

EN

19.04



# INSHORE SKIPPER

STUDENT  
TEXTBOOK



# TABLE OF CONTENTS



<b>Operational Checklist</b>	<b>1</b>	<b>IALA Buoyage &amp; Pilotage</b>	<b>25</b>	<b>Anchoring</b>	<b>47</b>
- Exercise 1	3	- Lateral Marks	25	- Types of Anchors	47
<b>Safety at Sea</b>	<b>4</b>	- Cardinal Marks	26	- Choosing the right spot	47
- Basic Guidelines	4	- Buoyage on Charts	27	- Dropping the Anchor	48
- Safety Equipment	4	- Lights	27	- Swinging Circle	48
- Fire Fighting	7	- Colours & Shapes	27	- Raising the Anchor	48
- Operating Extinguisher	7	- Sounds	27	<b>IRPCS</b>	<b>49</b>
<b>Navigation</b>	<b>8</b>	- Preferred Channel Marks	28	- Fundamental Rules	49
- Nautical Charts	8	- Sectorized Lights	29	- Risk of Collision	49
- Chart Symbols	9	- Clearing Bearings	29	- Sailing Rules	50
- Chart Datum	9	- Leading Bearings & Marks	29	- Shapes And Sounds	51
- Mercator Projection	10	- Exercise 2	30	- Lights	53
- Horizontal Datums	10	<b>Meteorology</b>	<b>31</b>	<b>Electronics</b>	<b>55</b>
- Compass Rose	11	- Weather Forecast	31	- Know Your System	55
- Magnetic Variation	11	- Format of Shipping Forecast	32	- GPS	55
- Deviation	12	- Terms used	32	- Depth Sounder	55
- The Globe	12	- Coriolis Effect	33	- Electronic Log	55
- Measurements	12	- Synoptic Charts	33	- Electronic Compass	56
- Latitude	13	- Formation of a Depression	34	- Wind Sensor	56
- Longitude	13	- Types of Clouds	34	- VHF Radio	56
- Plotting the Course	15	- Beaufort Scale	35	- Satellite Phone	56
- Dead Reckoning	16	<b>Handling Yacht Under Sails</b>	<b>37</b>	- AIS	57
- EP with 'Leeway'	16	- Points of sail	37	- iPad / Tablet	57
<b>Position Fixing</b>	<b>17</b>	- Luff Up	38	- Radar	57
- Quick Reminder	17	- Bear Away	38	- Chartplotter	57
- Converting	17	- Tacking and Gybing	39	- Autopilot	57
- Methods of Pos. Fixing	17	- Dangerous Gybe	40	<b>First Aid at Sea</b>	<b>58</b>
- Line of position	17	<b>Handling Yacht Under Power</b>	<b>41</b>	- First Aid Preparation	58
- Transit	18	- Gears	41	- First Aid Kit	58
- Transit & Bearing	18	- Inertia	41	- In an Emergency	58
- Fix w. Depth and Bearing	18	- Prop Kick	41	- Hypothermia	59
- Three Point Fix	19	- Turning Capability	42	- Head Injuries	59
- Running Fix	20	- Dock Lines	43	- Bleeding	59
<b>Passage Planning</b>	<b>21</b>	- Fenders	43	- Minor Burns	60
- Planning Your Passage	21	- Types of Berths	44	- Major Burns	60
- Course Shaping	22	- Leaving the Dock	45	<b>Environmentally Responsible Sailing</b>	<b>61</b>
- Harbour Approach	23	- Arrival at the Dock	46	<b>Topics Checklist</b>	<b>62</b>
- Clearing Bearings	23				
- Leading Lines & Lights	24				
- Navionics™	24				





# Course Content

The ISSA Inshore Skipper Certificate is a course aimed at candidates who have completed the ISSA Yacht Crew course and have a good understanding of sailing/boat handling, nautical terminology and safety at sea. The aim of the course is to increase the candidates' nautical knowledge to competently take on the duties of a inshore skipper on board a yacht, in daylight hours within sight of land.

Upon completion the students may be eligible to undertake the ISSA Offshore Skipper Course.

Tuition is provided by experienced and highly skilled ISSA Instructors using a combination of practical instruction and theoretical teaching. Student learning is enhanced using a variety of handouts and teaching aids with correct student/instructor ratios.

## THEORY TOPICS

**Taking over a vessel:** Hull and rig checks, machinery and systems checks, instrument checks, safety equipment checks

**Meteorology:** Sources of information, personal observation, weather patterns, sea and land breezes, cloud types and formations, precipitation and fog

**Pilotage and passage planning:** Pilot books, almanacs and information sources, passage planning considerations, navigating a coastal passage, passage strategy, port regulations, pilotage plans

**Vessel handling:** Anchoring mooring and MOB, berthing and leaving a berth, handling in confined areas with and against cross currents

**Chartwork:** Review of position fixing and running fixes, course to steer to counteract a current, effect of tide and plotting the effect of tides and currents

**Collision Regulations:** Review of collision regulations, lights, sound and shapes, application of the regulations

## PRACTICAL TOPICS

**Vessel Check-out:** Hull and rig checks, machinery and systems checks, instrument checks, safety equipment checks, fuel and water capacity

**Responsibilities of Captain/Skipper:** Communication with crew, delegation of crew seamanship general deck work, ropes, knots and splices, care and use of lines

**Vessel Handling:** Anchoring, mooring and MOB, berthing and leaving a berth, handling in confined areas, handling with and against cross currents



# Operational Checklist

The vessel you are using is in sound condition and has the full inventory as per the MCA Code of Practice for small commercial vessels. As a Skipper (in training) you should implement the operational process below to ensure safe

use of the vessel. Familiarise yourself with the vessel and her equipment.

ISSA has provided you with the following checklist to ensure this is possible.

## 1. As Skipper you should:

- Prepare a Passage Plan (if appropriate)
- Obtain an up to date Weather Forecast
- Collect navigation equipment (Charts etc.)
- Check all safety equipment location
- Complete pre-departure legal procedure (Customs and Immigration)

## 2. Pre-departure boat checks:

- **Above Deck**
- **Below Deck**
- **Engine Checks**
- **Generator Checks**
- VHF Radio Check
- Rig Checks
- Safety checks for the vessel

### ABOVE DECK

- ▶ Sails and spars
- ▶ Rigging
- ▶ Winches and handles
- ▶ Blocks and running gear
- ▶ Clutches and cleats
- ▶ Guardrails
- ▶ Jack stays
- ▶ Tiller and extension
- ▶ Sheets, lines and halyards
- ▶ MOB life ring with light
- ▶ Anchor and anchor winch
- ▶ Engine throttle control lever
- ▶ Life-raft attached correctly

### BELOW DECK

- ▶ Batteries (electrolyte level, terminals and voltage)
- ▶ Bilge (Ensure dry) Check Bilge pumps and float switches
- ▶ Safety equipment (lifejackets, harness lines, first aid, fire extinguishes, flares, Vhf, Navigation equipment, spare anchor, spare lines, fenders, tools and spare parts, EPIRB, SART, torches, fog horn, bungs, bucket, day shapes.
- ▶ Ensure everything stowed safely ready for going to sea
- ▶ Hatches are closed and secure
- ▶ Engine and gearbox (See below for checks)
- ▶ Electronics (GPS- chartplotter, VHF, nav lights, radar AIS, bilge pumps, water pump, Instruments)
- ▶ Heads
- ▶ Galley equipment and cooker
- ▶ Sea cocks and hoses
- ▶ Fresh Water tanks and fuel tank levels

## 3. Crew Briefing:

- Personal Safety briefing
- Boat Safety Plan
- Action to be taken in an emergency
- How to stop and start the engine
- Location of sea cocks
- Fire Brief
- Action to take in a MOB situation
- How to use the heads
- Where VHF is and how to use it

### ENGINE CHECKS

- ▶ Batteries (electrolyte level, terminals, wiring and voltage)
- ▶ Engine Mounting is secure
- ▶ Engine bilge is dry from oil and water
- ▶ Belts are tight and free from damage
- ▶ All hoses in good condition and securely fastened
- ▶ All electrical connections are clean and secure
- ▶ Fresh water header tank is topped up with coolant.
- ▶ Engine oil and gearbox oil level is correct and oil is not black
- ▶ Raw water seacock is open and hoses secure
- ▶ Fuel tank filled and fuel valve open
- ▶ Primary fuel filter/Water strainer doesn't have water at bottom.
- ▶ Engine housing for damage

### GENERATOR CHECKS

- ▶ Observe for obstructions around stern of vessel
- ▶ Throttle lever in Neutral
- ▶ Turn on ignition
- ▶ Start with key or button
- ▶ Ensure cooling water and exhaust gases are being expelled at stern
- ▶ Observe electronics panel for warning lights or alarms
- ▶ Check ahead and astern gears
- ▶ Leave engine to warm up
- ▶ Check for leaks on all cooling, fuel, oil and exhaust system

#### 4. Provisioning check:

- Water and drinks
- Food and snacks. Enough for 100% of Passage + 20%
- Grab bag prepared
- Medical supplies
- Adequate clothing for any weather conditions

#### 5. Before leaving port, remember:

- Weather forecast and tidal information
- Crew list and relevant documents
- Passage Plan
- Contact relevant authorities (Harbour master, Immigration, Customs)
- Leave information ashore

#### 6. When returning to port, remember:

- Boat correctly moored and fendered
- Fuel and water tanks refilled
- Rinse boat with fresh water
- Sails dried and stowed
- Safety equipment dried and stowed
- Tidy all lines, sheets and halyards
- All electrics turned off and batteries off (Cover instruments)
- Check no water in the bilge
- Check seacocks closed
- Check fuel system and turn off fuel valve
- Fridge left open to air
- Lock hatches and washboard



# EXERCISE 1

Please make your own pre-departure check lists now.

Write down the 6 most important items, in your opinion, to be checked

## ABOVE DECK CHECK LIST

- 1.....
- 2.....
- 3.....
- 4.....
- 5.....
- 6.....

## BELOW DECK CHECK LIST

- 1.....
- 2.....
- 3.....
- 4.....
- 5.....
- 6.....



# Safety at Sea



## BASIC GUIDELINES

Hazardous situations at sea happen rarely but frequently enough to make training for them meaningful. Here are some basic rules to follow:

- Always maintain and service your safety equipment on regular basis.
- Always make a safety briefing for the crew.
- Make sure the crew knows the location of the safety equipment.
- Make sure the crew knows how to use the safety equipment.

**As a certified Inshore Skipper, you are in command and you are responsible for the safety of every single person aboard, including yourself.**

## SAFETY EQUIPMENT

**Life Jackets:** You are obliged to always have a sufficient number of the SOLAS Life Jacket aboard. Life jacket keeps the head of an unconscious person above water.

There must be always at least **ONE LIFE JACKET PER PERSON** aboard. Life Jackets must be fitted with reflective tapes, whistle, and a flashlight. You can choose between solid/rigid ones and inflatable life jackets. However, keep in mind please that the inflatable ones must be serviced each year.



**Personal Flotation Device (PFD):** It is more convenient to wear, thus more popular and often used in water sports activities. However, **THIS IS NOT AN ALTERNATIVE TO THE LIFE JACKET.**

PFD provides only flotation features. It requires you to be conscious and able to swim as in some cases it might not support the whole weight of your body. PFD will not keep the unconscious person's head above water.

**Distress signaling equipment** is used to attract attention in case of an emergency at sea. There are three different types of pyrotechnics used as distress signals:

**Red distress rockets** - most effective during the night. They go up to 300m and should be fired pointing downwind.



**ALWAYS FIRE DOWNWIND**  
**DO NOT USE ROCKETS NEAR HELICOPTERS**

**Red hand flares** - used mainly when other vessels are in the vicinity. They attract more attention if you wave them. They get extremely hot.



**ALWAYS FIRE DOWNWIND**  
**DON'T LOOK DIRECTLY ONTO BURNING FLARE**

**Orange smoke** - most effective during daytime and most visible to aircraft. It burns for 3 minutes and apart of attracting attention, it shows the direction of the wind.



**White hand flares** - are not distress signals. They are used to attract attention in order to avoid collision at night.



**All the pyrotechnics have expiry dates. Make sure your equipment is always up to date.**

**Other safety equipment** may vary across the vessels. On the following images you'll find items to be found on a well equipped yacht.



1 Ring buoy



2 Horseshoe buoy

**GENERAL**



3 First Aid Kit

# GENERAL



4 Fire extinguisher



5 Fire blanket



6 Toolbox

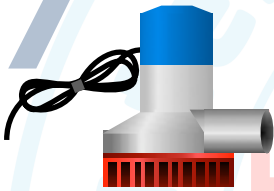

7 Electric bilge pump



8 Manual bilge pump

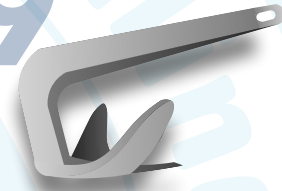

9 Spare anchor



10 Handheld VHF Radio

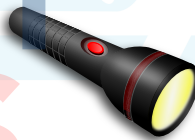

11 Waterproof flashlight



12 Extra horn

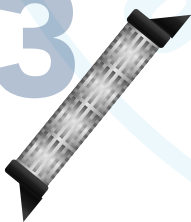

13 Radar deflector



14 Magnetic compass



15 Extra rope

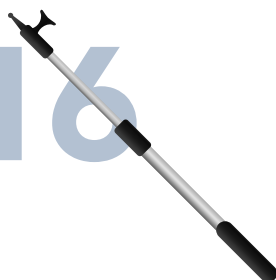

16 Boat hook

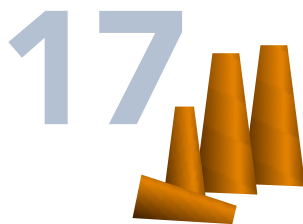

17 Wooden bunks

Always check your safety equipment before sailing

## FIRE FIGHTING

There are different classes of fire (depending on the fuel that is burning) and different types of fire extinguishers. It is important to use the right extinguisher for the job.

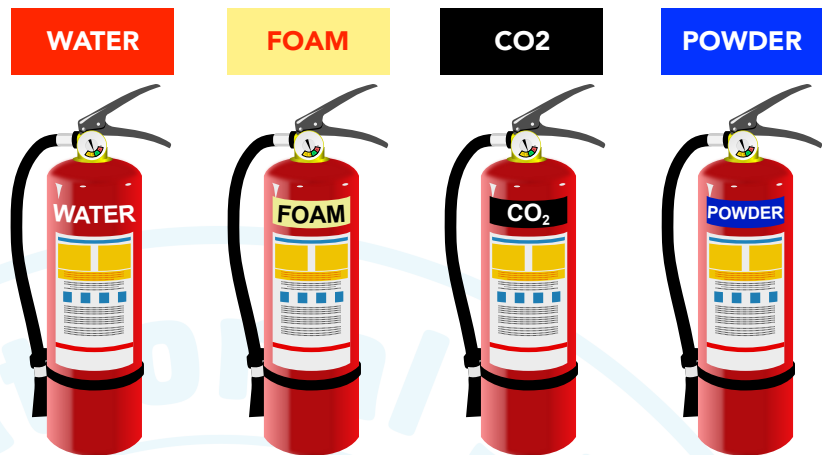

<b>A Solids</b>		<b>WATER</b>	<b>FOAM</b>	<b>CO2</b>	<b>POWDER</b>
<b>B Liquids</b>			<b>FOAM</b>	<b>CO2</b>	<b>POWDER</b>
<b>C Gases</b>					<b>POWDER</b>
<b>Electrical</b>				<b>CO2</b>	<b>POWDER</b>

**Fire triangle** shows the necessary ingredients for most fires. It illustrates the three elements a fire needs to ignite: **heat, fuel, and an oxidizing agent (usually oxygen)**.



**Powder extinguisher is the best one to use aboard small vessels.**

## OPERATING EXTINGUISHER

Every extinguisher is used in the same way. However always check the instructions written on the fire extinguisher.

1. Pull the safety pin.
2. Aim the nozzle at the base of fire.
3. Squeeze the handle.
4. Sweep the nozzle side to side.

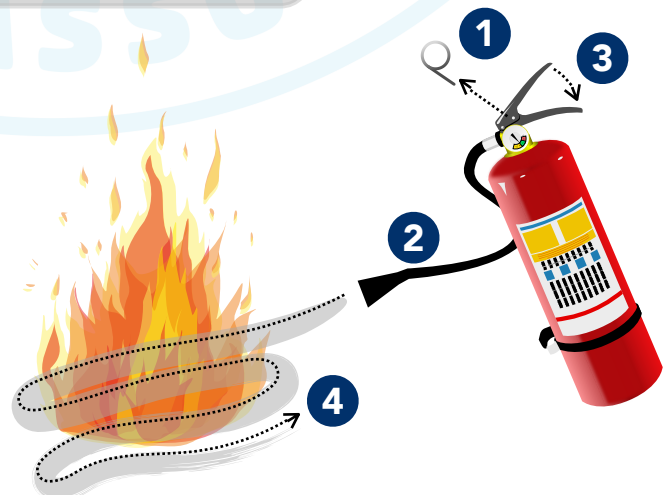

# Navigation



## NAUTICAL CHARTS

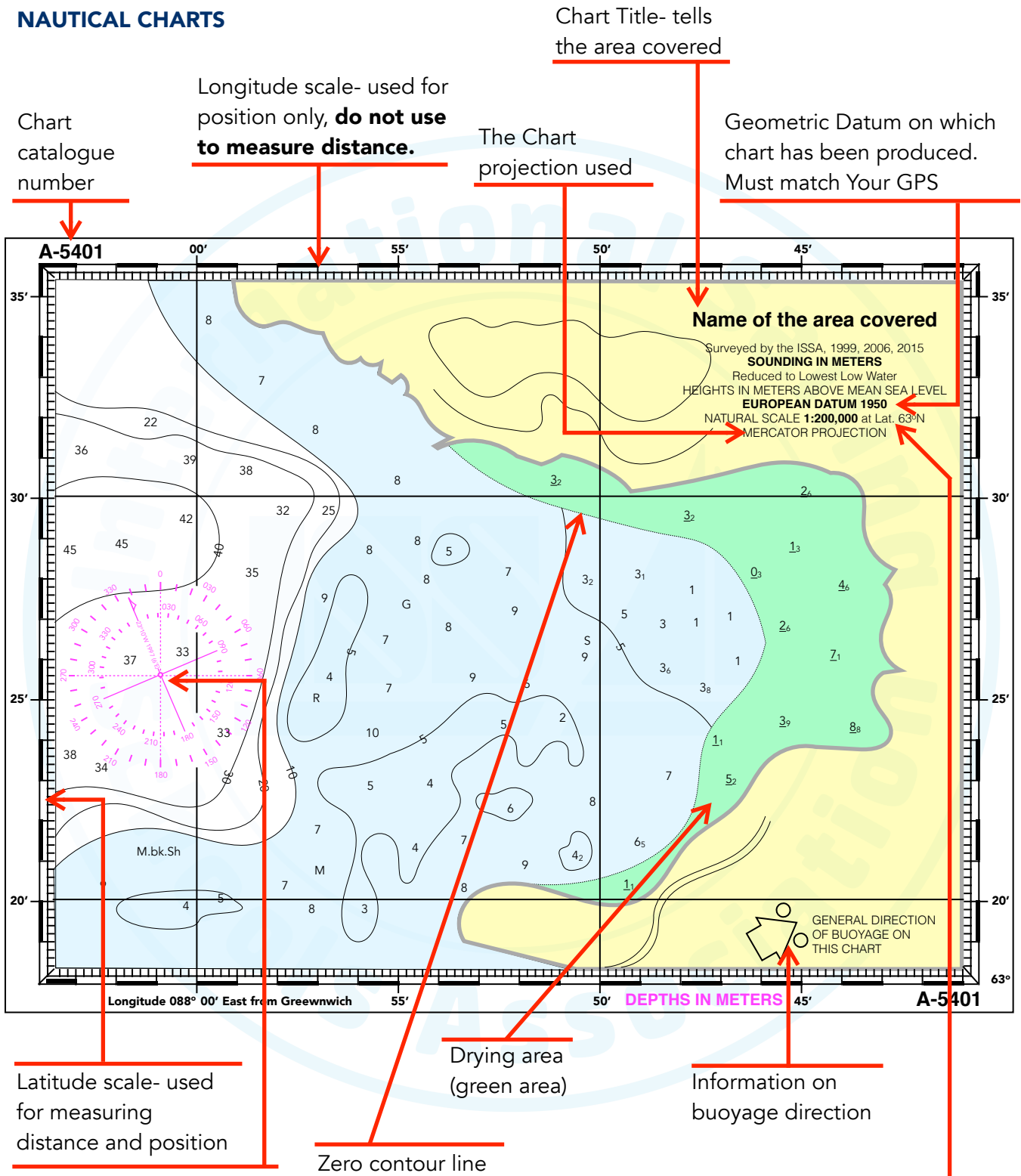

Compass rose- used for plotting your position, use center as a waypoint

Magnetic variation can be found on the compass rose

## CHART SYMBOLS

All Charts contain symbols that are internationally standardised. Though you should be familiar with commonly used symbols and light signatures, the sheer number of symbols makes it impossible to remember them all.

The **5011 Chart Symbols and Abbreviations** is one of the most important documents a navigator has. It is used to decipher the various symbols found on a nautical chart. It is also available as an App for phone or tablet.

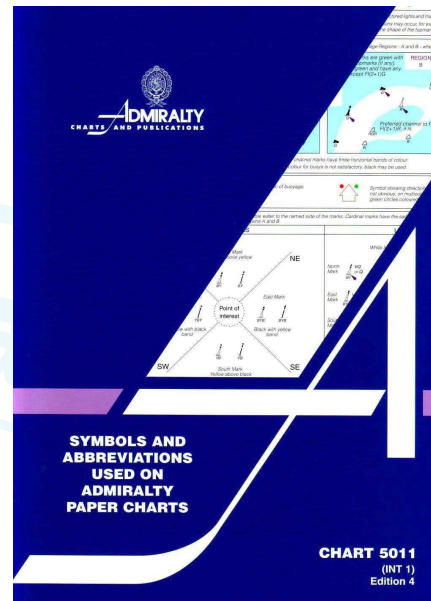

## CHART DATUM

Chart Datum is the reference point for all depths on a chart. It can be the lowest astronomical tide on record – the theoretical minimum. On some charts however, it is the mean lowest low tide – the average of the lower of the two low tides in a day. As this is not the theoretical minimum, it is important to know what your chart datum is set to, to avoid running aground.

**The zero contour line is the line between Drying Height and Chartered Depth.**

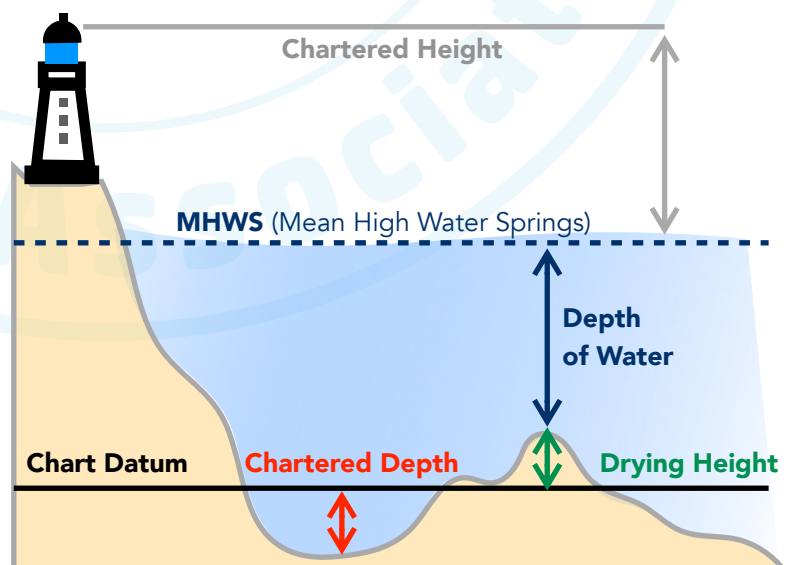

## MERCATOR PROJECTION

Projections are a means of representing a 3D object on a 2D surface.

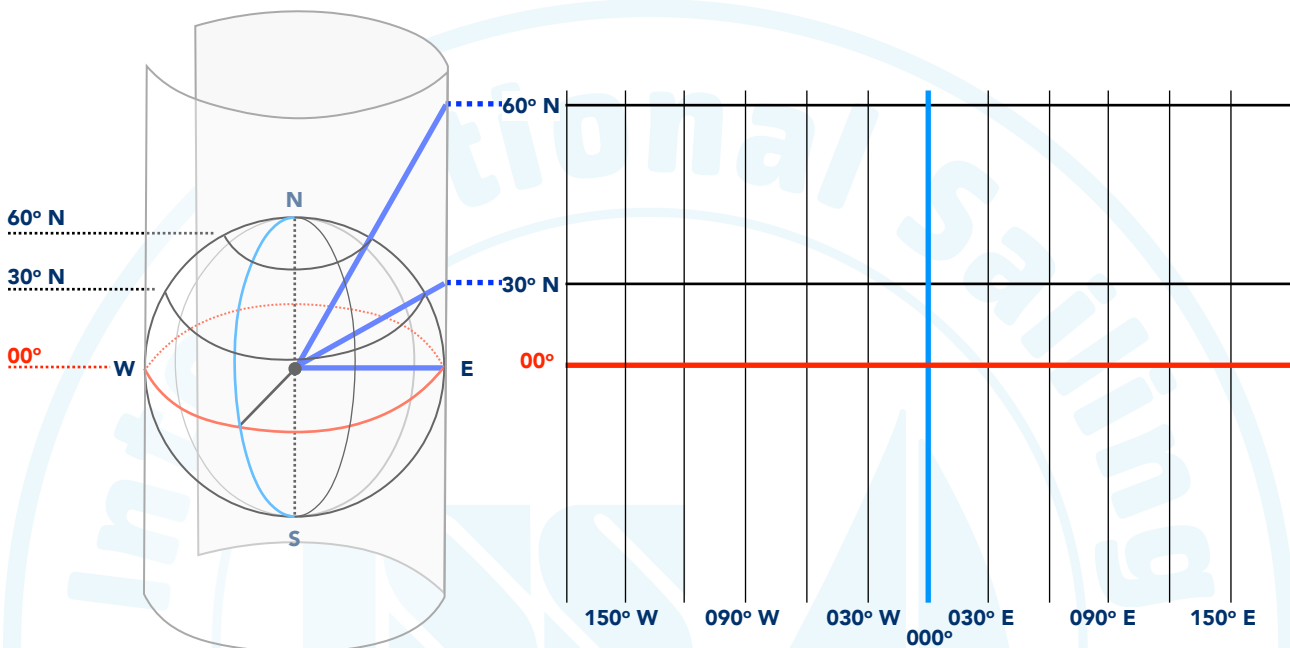

- Project light from the center of a sphere onto a cone.
- Most commonly used with large scale maps.
- **Advantage** is a straight line will always be at the same heading.
- **Disadvantage** – A straight line may not be the shortest route over long distances and as you near the poles.
- Transverse for long coastlines North to South.

## HORIZONTAL DATUMS

Over time cartographers have been busy producing their own charts. This has made any type of conformity very difficult and hundreds of datum points are in existence. The standard datum **WGS 84** was finally adopted and all UKHO and Imray charts now use this datum (or one that is compatible).

**Check charts when taking over a vessel and if necessary make the appropriate adjustments on the GPS for the chart.**

## COMPASS ROSE

The compass rose tells us the difference between True North and Magnetic North for each chart.

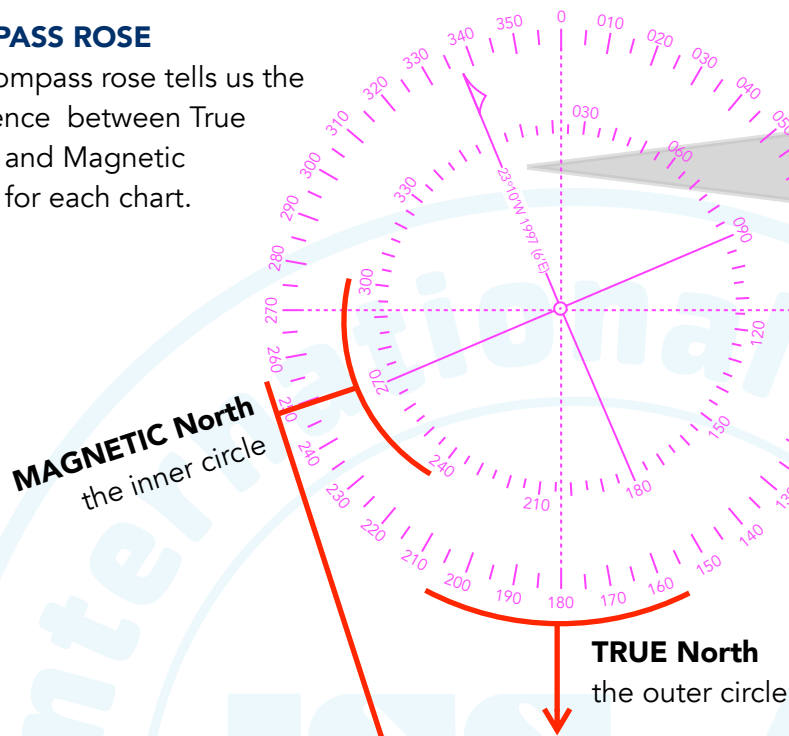

In **1997** the difference was **23°10'W**.  
Every year since then, the Magnetic North moves **6'E**.

## MAGNETIC VARIATION

The difference between True North and Magnetic North is called **Variation**

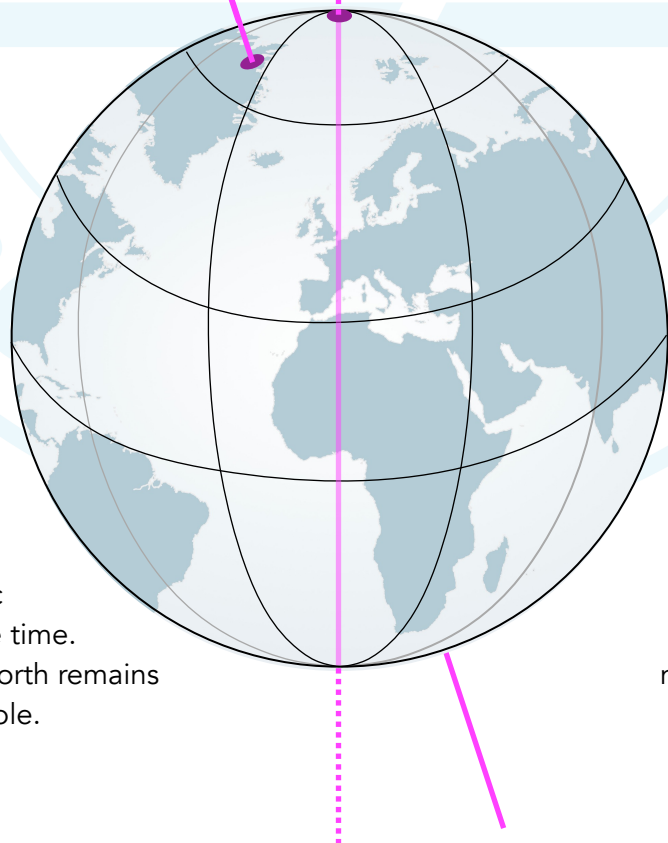

The origin of Magnetic North is moving all the time. The location of True North remains the same: the North Pole.

You must factor this **VARIATION** into your navigational calculations in order to be accurate.



## DEVIATION

Deviation is caused by ferrous objects and materials on the yacht which affect the compass. It can be caused by the following objects:

- Engine
- Steel Emergency Tiller
- Binnacle Mounting
- Electric and Electronic Components and Wiring
- Radios
- Cockpit Speakers
- Binoculars

Deviation can be plotted onto a graph or chart that enables us to know the amount on each heading, and correct our route accordingly. This is known as a **Deviation Table**.

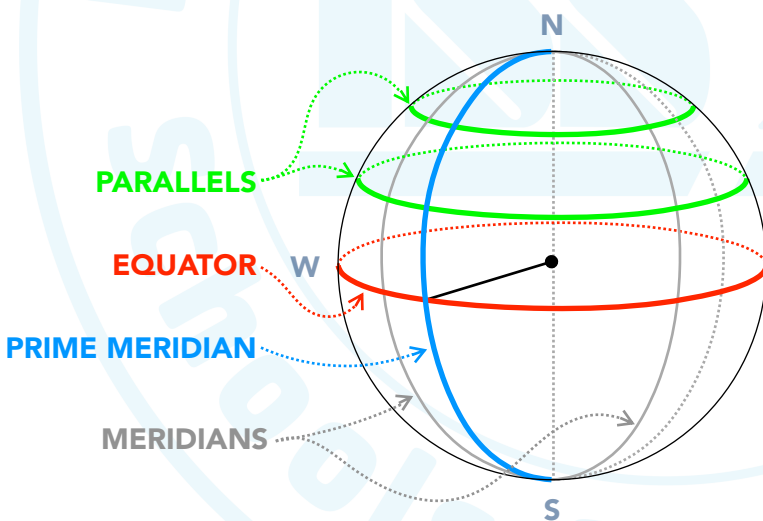
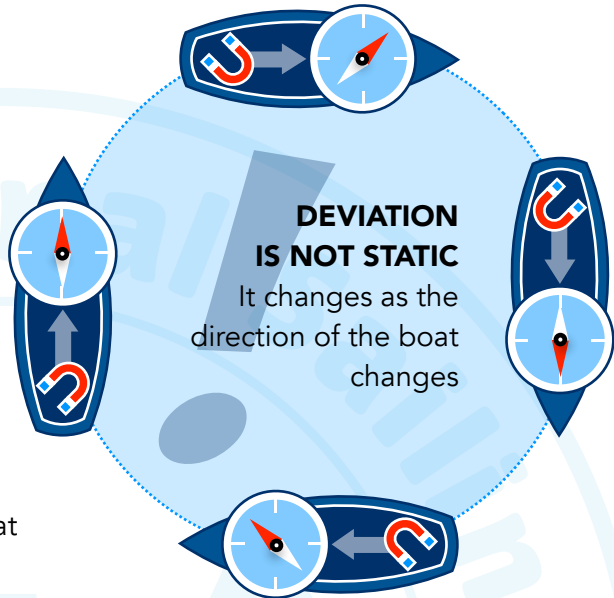

## THE GLOBE

The globe is a ball, just under 13,000 km in diameter. The ball is actually slightly squashed but this distortion is so small that for many practical purposes we can simply ignore it.

Thus we can visualise the globe as a perfect sphere, whose surface is covered by an invisible grid of lines.

## MEASUREMENTS

**1° = 60' = 360"** → POSITION  
1 degree                  60 minutes                  360 seconds

**1' = 1 NM = 1852 m** → DISTANCE  
1 minute                  1 nautical mile **ON EVERY MERIDIAN**

**1 kn = 1 nm/h** → SPEED  
1 knot                  1 nautical mile per hour

LATITUDE

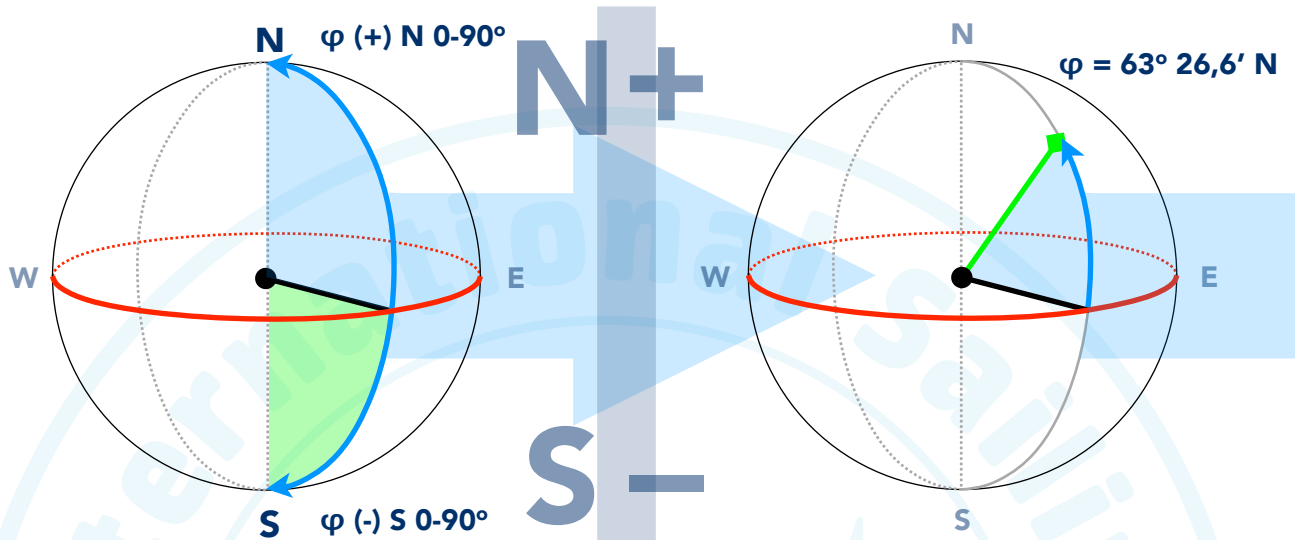

LONGITUDE

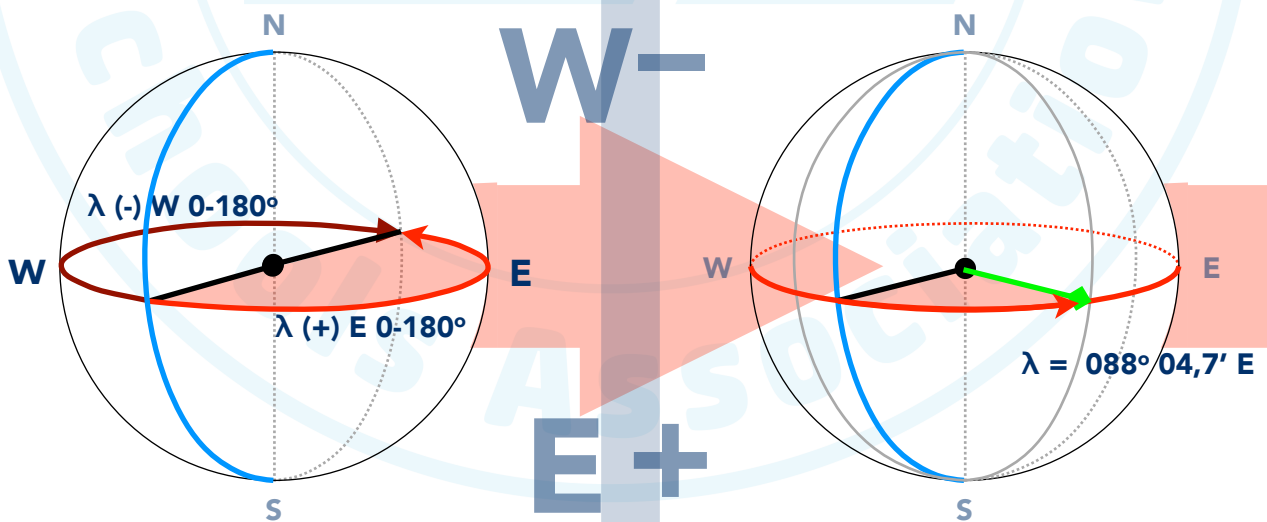

**NEWS**  
 + + - -

## LATITUDE

**Latitude scale**  
used for  
measuring  
distance and  
position

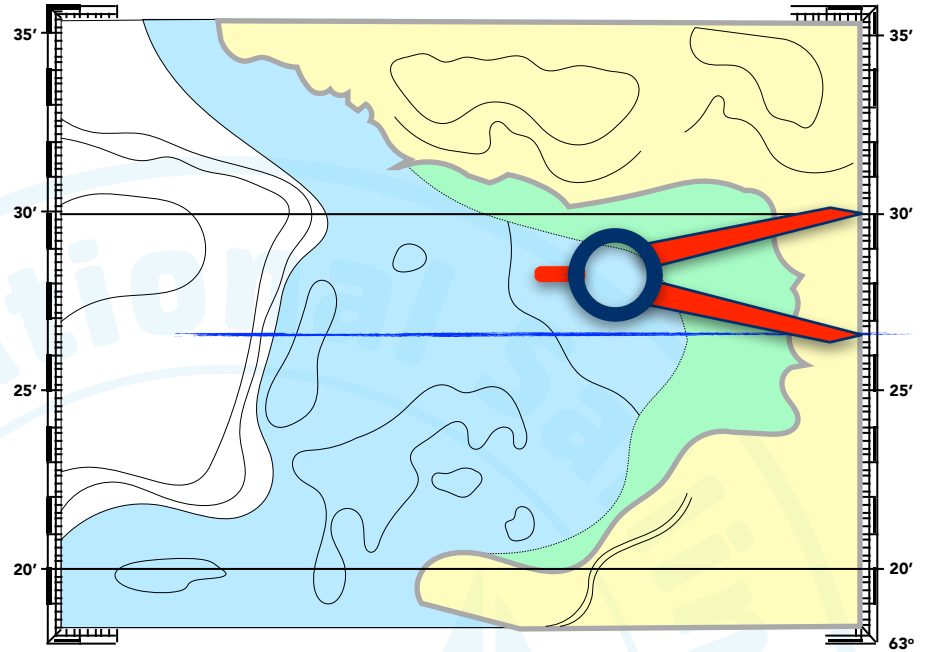

## LONGITUDE

**Longitude scale** used for  
position only,  
**do not use**  
to measure  
distance.

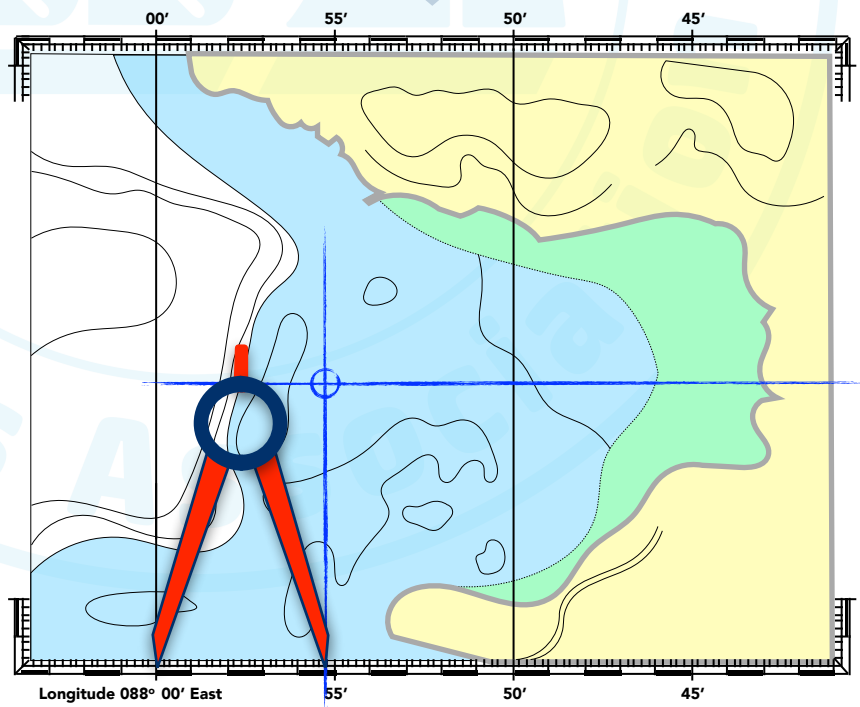

## PLOTTING THE COURSE

In maritime navigation direction (course) is plotted on the map as a straight line passing through the two points. That direction is determined by the angle between the direction of the north and the direction of the line. You plot your course using navigational triangle.

**Always place the triangle with its right angle towards You as reading always faces this angle.**

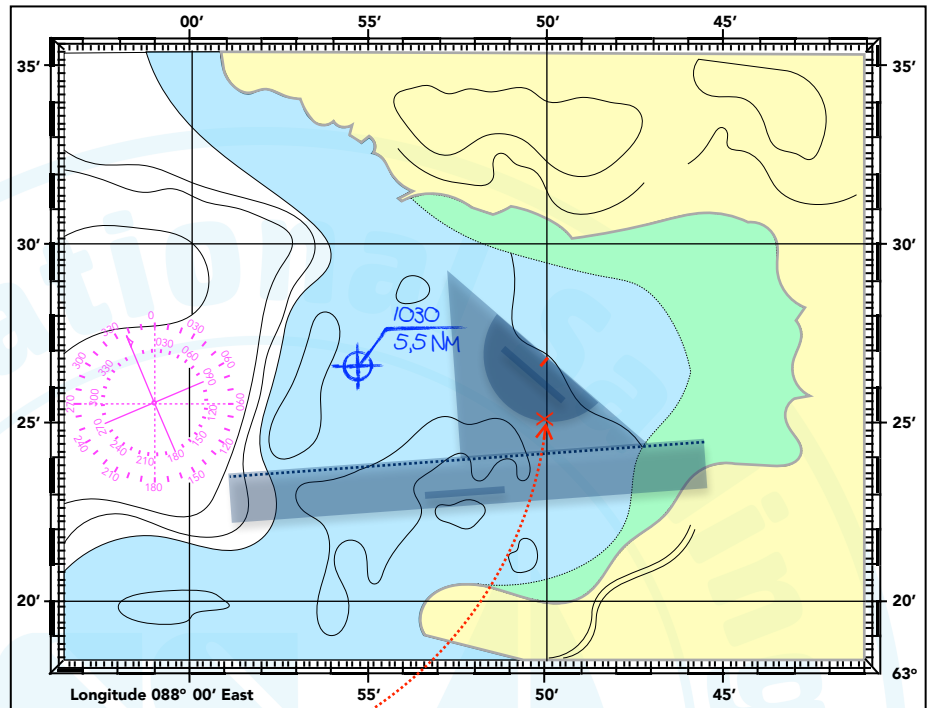

To the right of the meridian courses are from  $0^\circ$  to  $180^\circ$  (the triangle exterior scale), and to the left of the meridian are courses from  $180^\circ$  to  $360^\circ$  (the triangle internal scale).

### Remember:

Draw the course line ( $T^\circ$ ) after taking into consideration:

- Variation
- Deviation
- Leeway

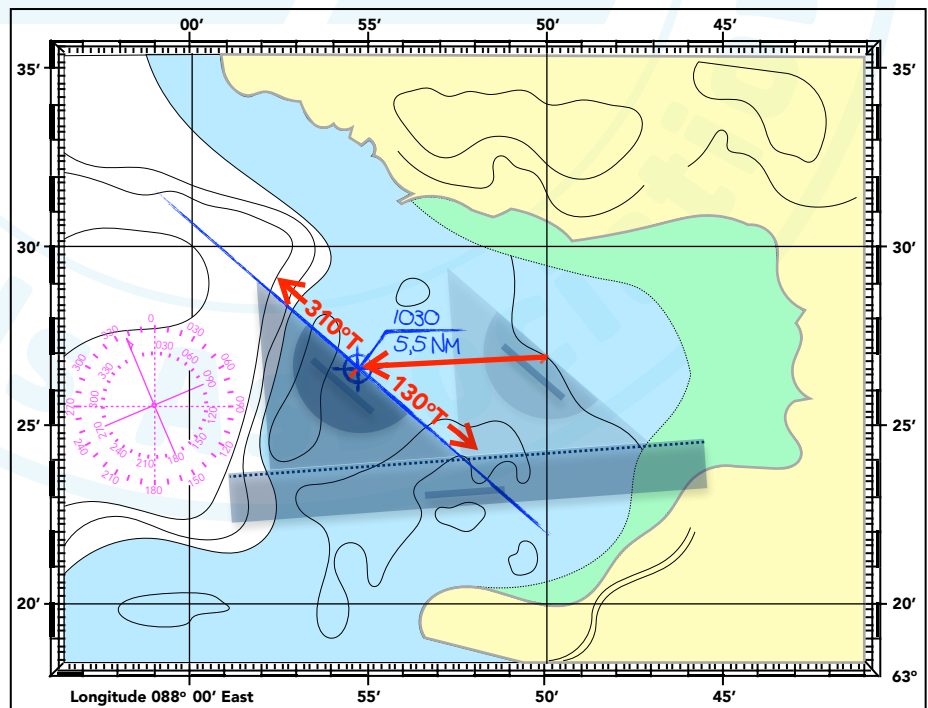

# Navigation



## DEAD RECKONING

In navigation, Dead Reckoning is the process of calculating your current position by using a previously determined position, and advancing that position based upon your speed over time (from the Log) and course (from the Compass).

However, if the first fix is inaccurate, the new DR will also be inaccurate. It also ignores the effect of the tide. For this reason to gain a more accurate fix we use what is known as an **Estimated Position (EP)**

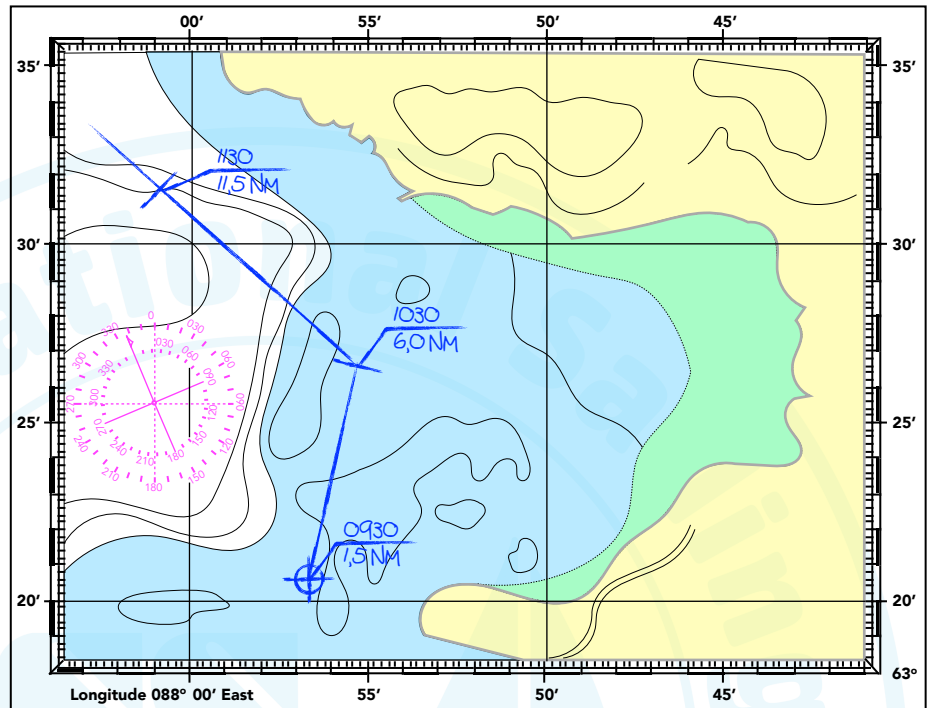

## EP WITH "LEEWAY"

Leeway is the sideways effect of the wind on the yacht. As a navigator you must factor this effect into your calculations and chartwork. The amount of sideways slippage will depend on the keel shape of the yacht you are sailing.

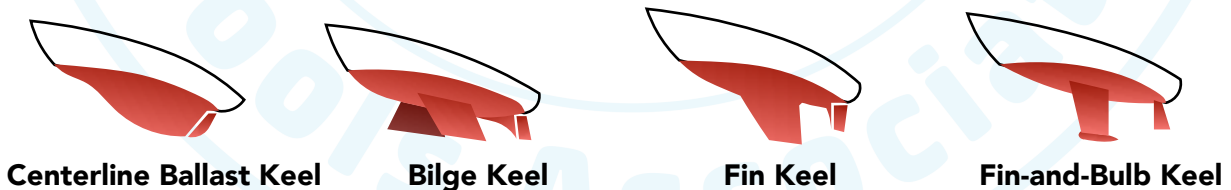

A longer keel yacht will only slip 5-10°, whilst a bilge keel yacht can slip up to 20°.

You must factor in the effect of leeway into our navigation but you **do not plot Leeway on the chart:**

**Water Track IS PLOTTED on the chart not Heading!**

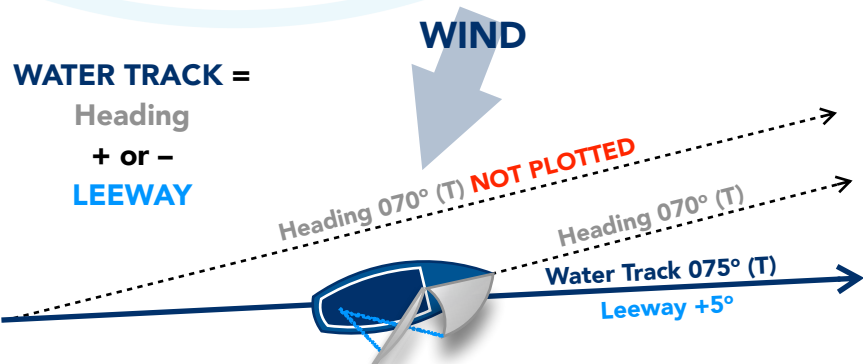



# Position Fixing

## QUICK REMINDER

Variation and deviation effect steering compasses. Handheld bearing compasses are only subject to variation



## CONVERTING

Use these mnemonics to convert compass to true and vice versa.

**CADET** = From COMPASS TO TRUE we ADD EAST (or – West)

**TAWC** = From TRUE TO COMPASS we ADD WEST (or – East)

## METHODS OF POSITION FIXING

- ▶ Line of Position
- ▶ Depth and Bearing
- ▶ 2 Point Fix
- ▶ 3 Point Fix
- ▶ Dead Reckoning
- ▶ Estimated Position
- ▶ Estimated Position with Leeway
- ▶ GPS Fix
- ▶ RADAR Fix
- ▶ Plotters and Overlay Radar
- ▶ Buoy (IALA)

The **accuracy** of your FIX **increases** as we move **down the list**. As Inshore Skippers you are expected to use a range of these methods to establish your location.

# 1

## LINE OF POSITION

Line of Position involves taking one fix on a stationary object.

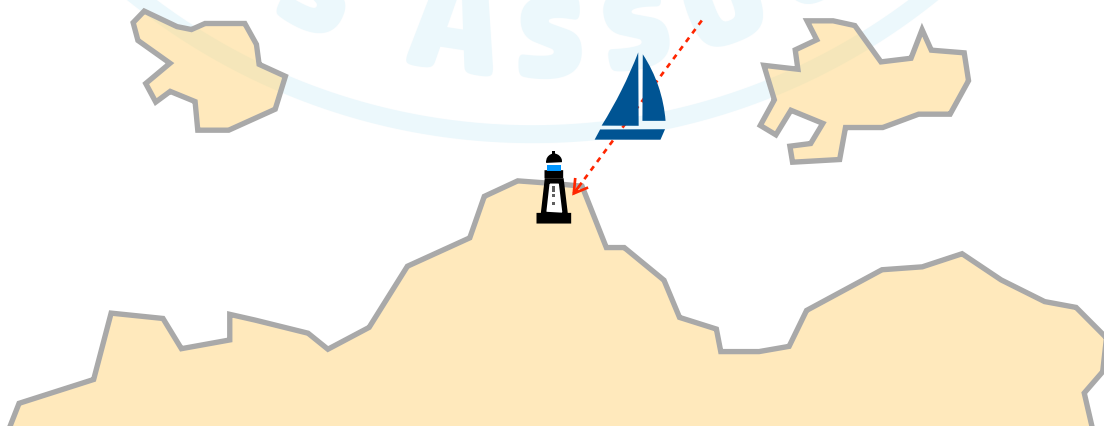

## TRANSIT



Nearing the TRANSIT.  
Turn to STARBOARD.

On the TRANSIT.  
LINE OF POSITION  
confirmed.

Passed the TRANSIT.  
Turn to PORT.

## TRANSIT & BEARING

You can combine a TRANSIT with a LINE OF POSITION to improve its accuracy.

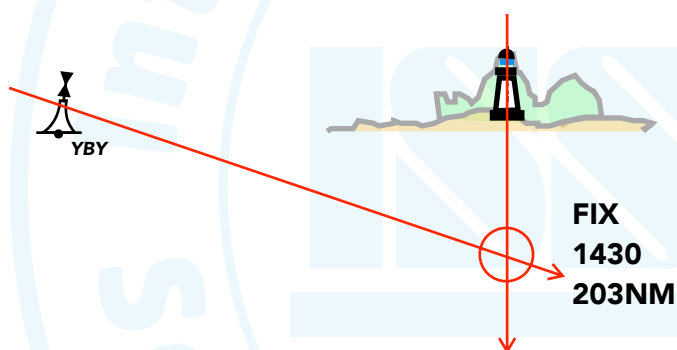

### Step 1:

Keep the mountain and lighthouse in transit.  
Draw this line on the chart.

### Step 2:

Add another bearing using the West Cardinal mark, giving you your location along the transit line.

# 2

## FIX WITH DEPTH AND BEARING

Another way we can confirm our position with some degree of accuracy is by using our depth sounder.

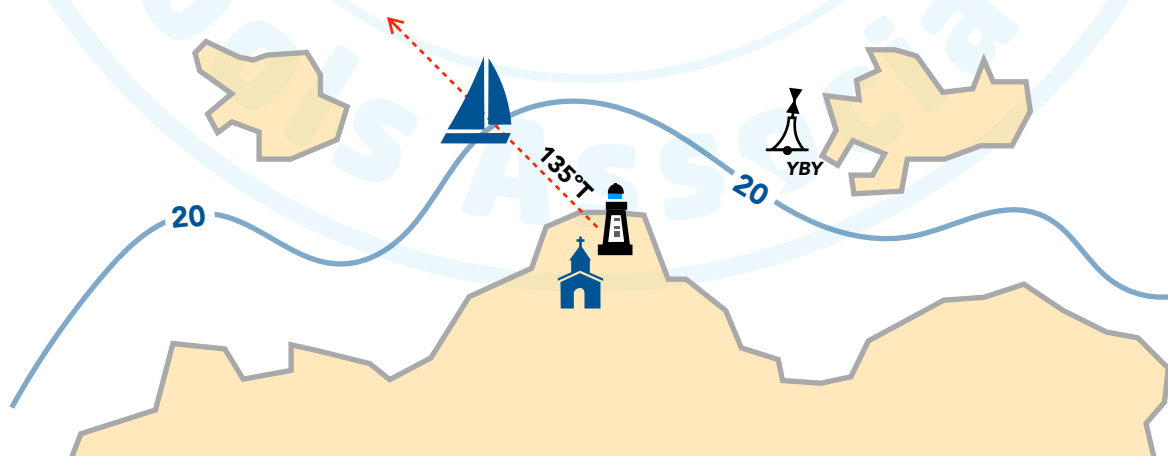

**1415 Lighthouse at 135°T Depth 20m**

Take a bearing on an object, and use the depth contours on the chart to confirm your location.

## 3

### THREE POINT FIX

A Line of Position doesn't give your exact position, just a position on a line. So take three bearings to improve your accuracy.

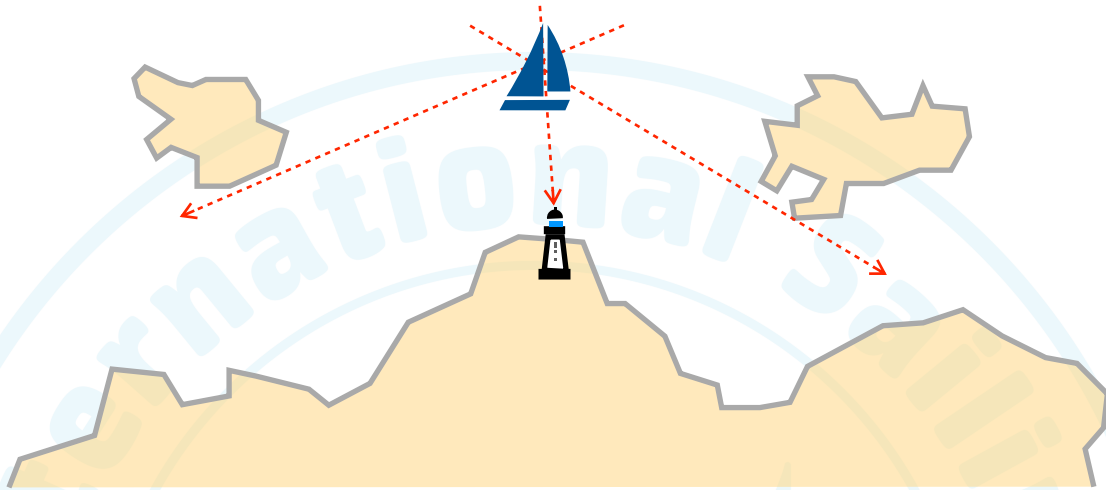

This is called a Three Point Fix

Your Three Point Fix may not always be entirely accurate. This can be caused by inaccurate readings on the compass, or taking too long

to sight your bearings. If it isn't accurate you will end up with a triangle where our lines of sight meet. This is called a **cocked hat**.

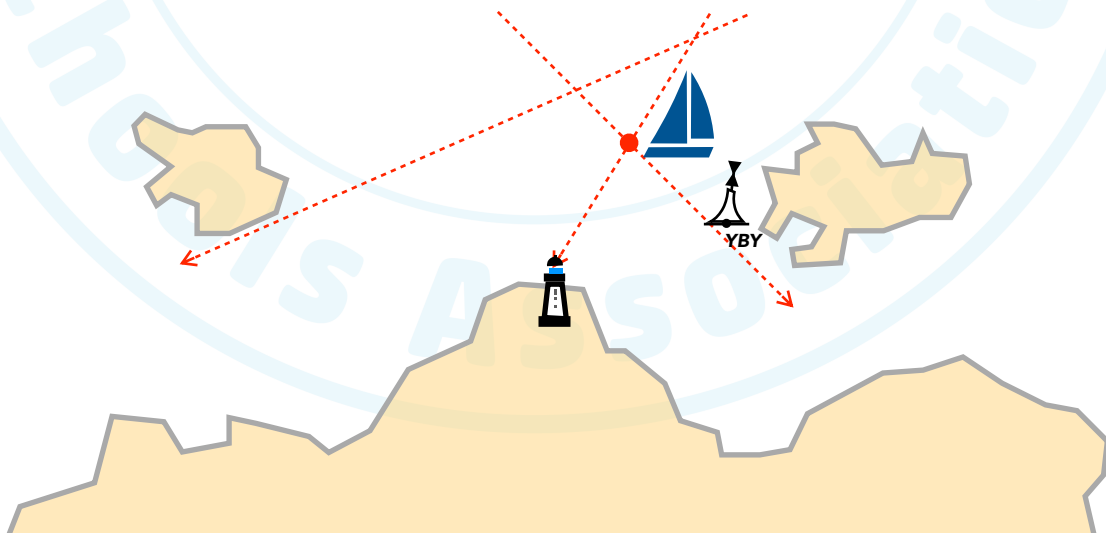

As you might be unsure of your exact location, you should plot your position at the closest point to danger.



# Position Fixing

## 4

### RUNNING FIX

A running fix, employed when only one object for a fix is visible, is obtained from two separate bearings taken of the same object, combined with the direction and distance travelled by the vessel.

#### Step 1:

Take a bearing on an object.

1030  
150NM

#### Step 2:

Plot your heading on the chart. It doesn't matter where you place this line along the bearing.

90°T

135°T

#### Step 3:

One hour later, take a second bearing on the lighthouse. Mark this bearing on the chart.

#### Step 4:

Using the dividers, measure the distance you have travelled, deduced by boat's speed and the time between the two bearings. In this example, the yacht has been traveling at 5 knots for 1 hour, therefore covering 5NM between the two bearings.

1030  
150NM

5NM

90°T

135°T

1130  
155NM

#### Step 5:

Redraw first bearing from the end of the dividers and mark your time, location and log on the chart.



# Passage Planning

## APPRAISAL

Creating a detailed mental and chart-based model of how the voyage will proceed. Gather and consider all relevant information: charts, weather, tides, almanacs etc.

## PLANNING

### Pre-departure Checks

Produce a detailed plan of your route on your chart, plotter or iPad, factoring in the weather, tides, buoyage, pilotage and Plan B. Communicate this to your team.

## EXECUTION

### Leaving Harbour A

### Pilotage

### Arrival at Harbour B

It is the skipper's responsibility to treat the plan as a "Living Document". Delegate roles to the crew and execute the intended plan accordingly.

## MONITORING

### DRs, EPs, Fixes

Regular checks and monitoring of the progress of the vessel along its planned route. DRs, EPs, Ship's Log, fixes, updating the chart. All crew must be able to confirm their location.

1

## APPRAISAL

## PLANNING

### PLANNING YOUR PASSAGE

As Inshore Skippers it is your legal and moral obligation to plan your passage well in advance. A good skipper should:

- **Organize crew** – How many, how experienced, strengths and weakness?
- **Study the weather** – Seasonal changes, what is to be expected?
- **Navigation Equipment** – Charts, Navionics, pilot books, almanacs, tidal atlases.
- **Plan B** – A second option in the event of an emergency.
- **Victualing** – Organise sufficient food and provisions for the crew and the length of trip.
- **Boat Checks** – Ensure the boat is in good working order and that you carry spares.
- **Communications** – Internet, radio, EPIRB, SART, VHF, mobile phones, batteries.
- **Dangers** – Be aware of potential threats to the boat.

## 2 EXECUTION

### COURSE SHAPING

When entering or leaving a PORT or HARBOUR, the tide may alter your course. Use a **TRANSIT** to ensure you stay on course.

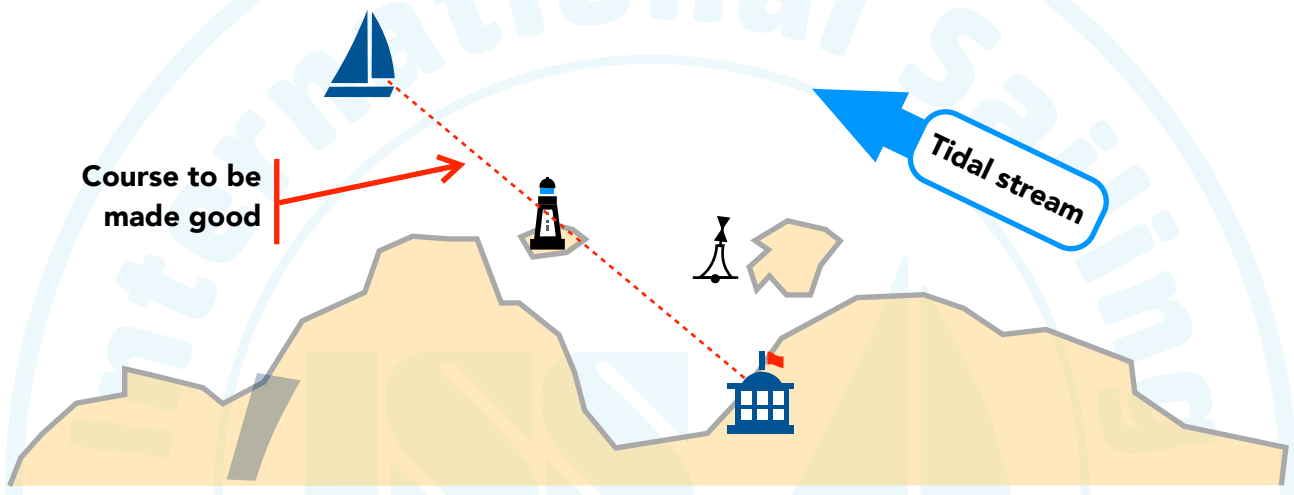

Get on any natural TRANSIT and steer into tide to stay on it.

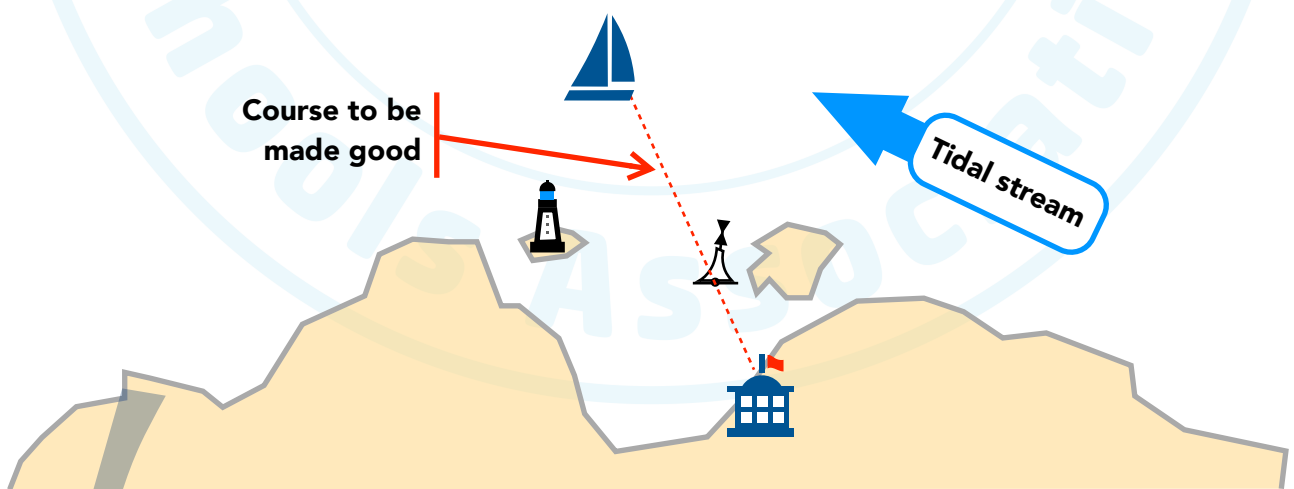

When close enough to see, transfer to more appropriate TRANSIT until out of tide.

## HARBOUR APPROACH

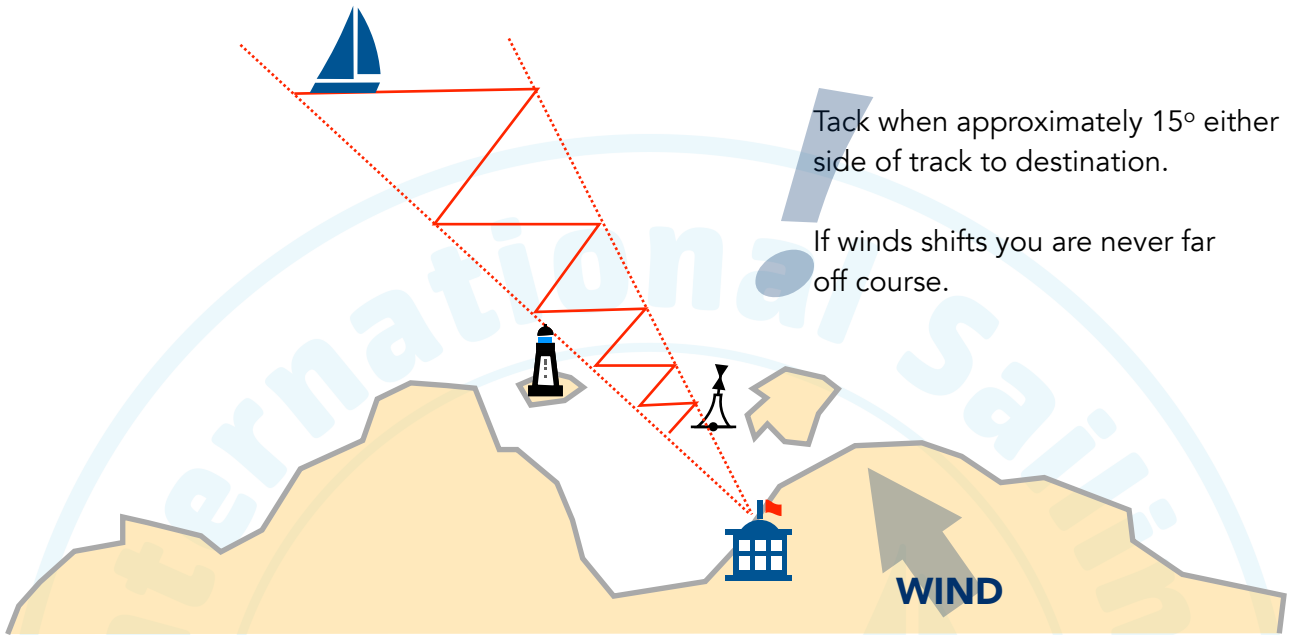

## CLEARING BEARINGS

If there are HAZARDS either side of a channel entrance, take CLEARING BEARINGS to avoid crossing into their path. Stay within these constraints to avoid the dangers.

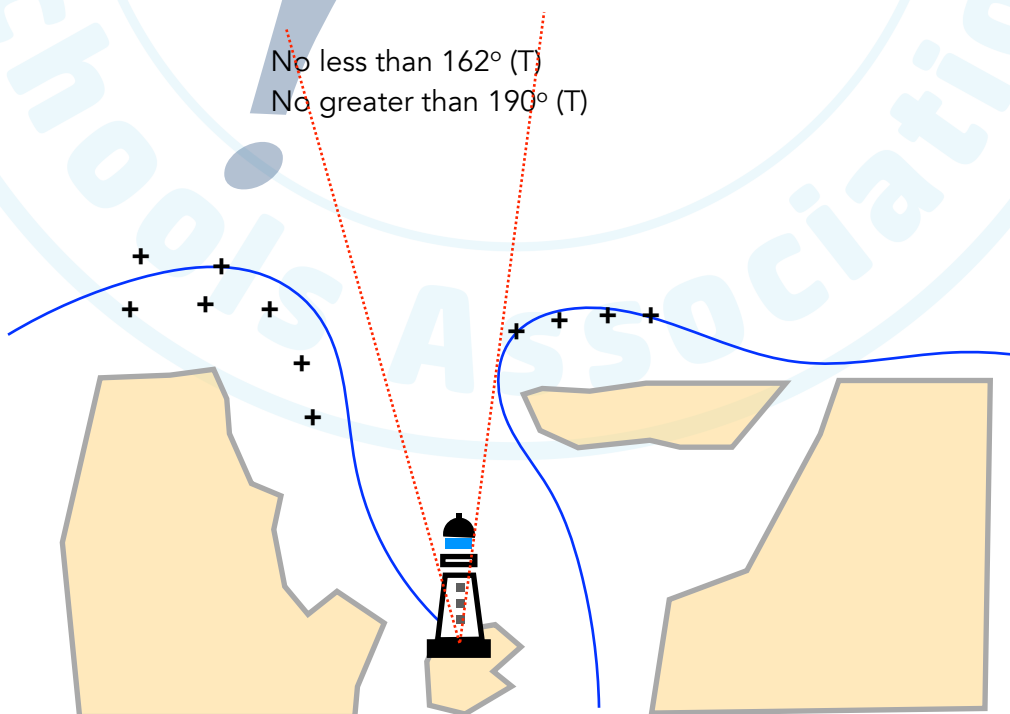

# Passage Planning



## LEADING LINES & LIGHTS

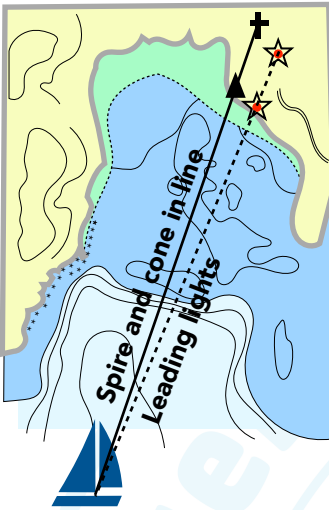

LEADING LINES & LIGHTS are a transit that will lead the vessel through hazards to safety.

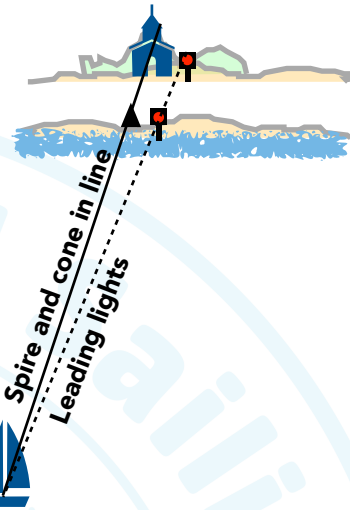

POSITION LINES can be used in conjunction with LEADING LIGHTS to ensure a safer approach.



Keep the buoy on 228° until leading lights are in transit.

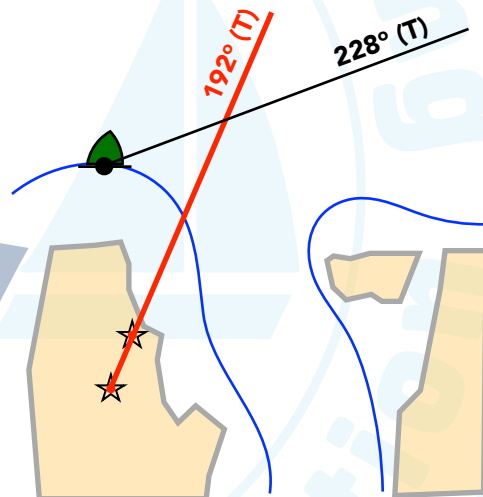

## NAVIONICS™

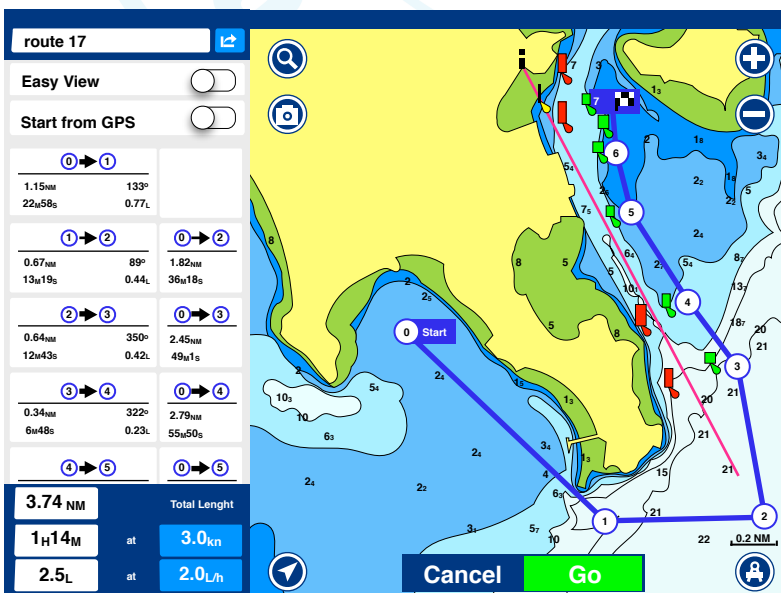

Electronic charts in leisure sailing are very useful. There are many software providers, some using only one sort of chart and others able to use several. The ability to use multiple types of charts, including those used by dedicated chartplotters, is probably the ideal.

You can download the software onto your smartphone or iPad/tablet.



# IALA Buoyage & Pilotage

Established in 1957, IALA (International Association of Marine Aids and Lighthouse Authorities) is a non-profit international technical association. IALA provides nautical expertise and advice. There are two IALA systems based on geographical location: Region **A** and Region **B**

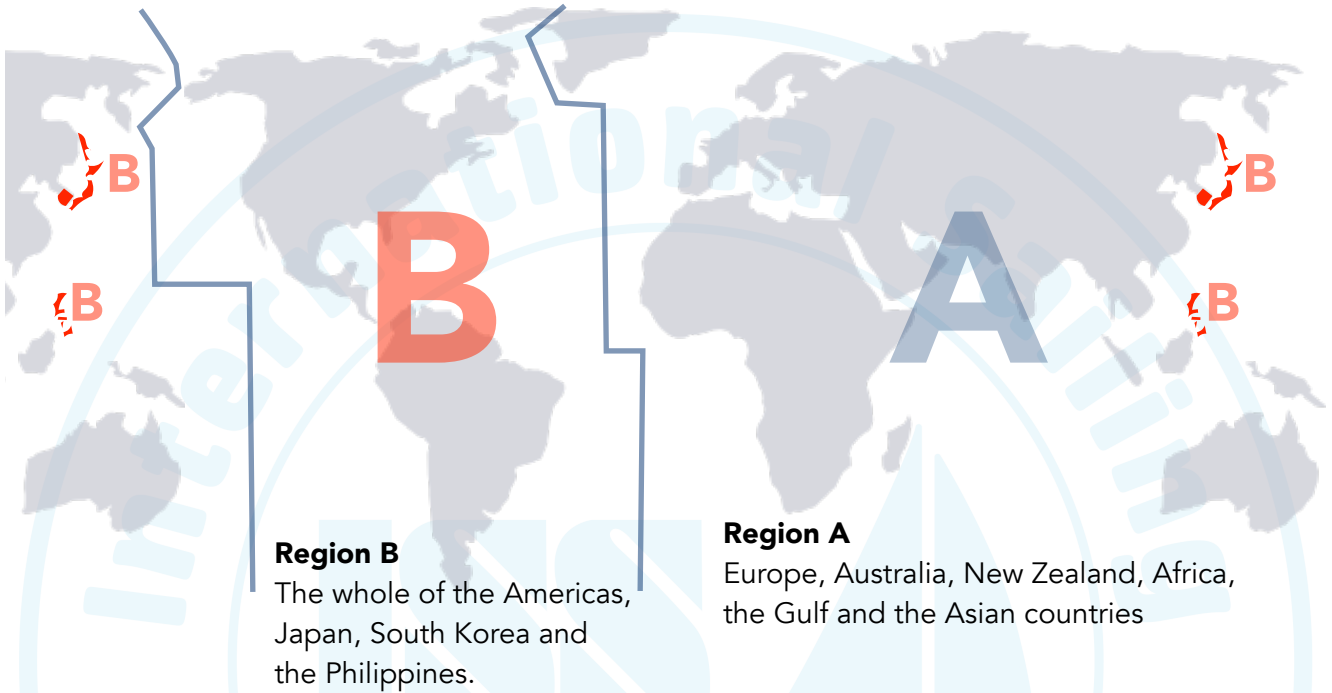

## LATERAL MARKS

When entering a port or harbour, the LATERAL MARKS ensure you stay in the required channel. We show here marks for the IALA Region A.

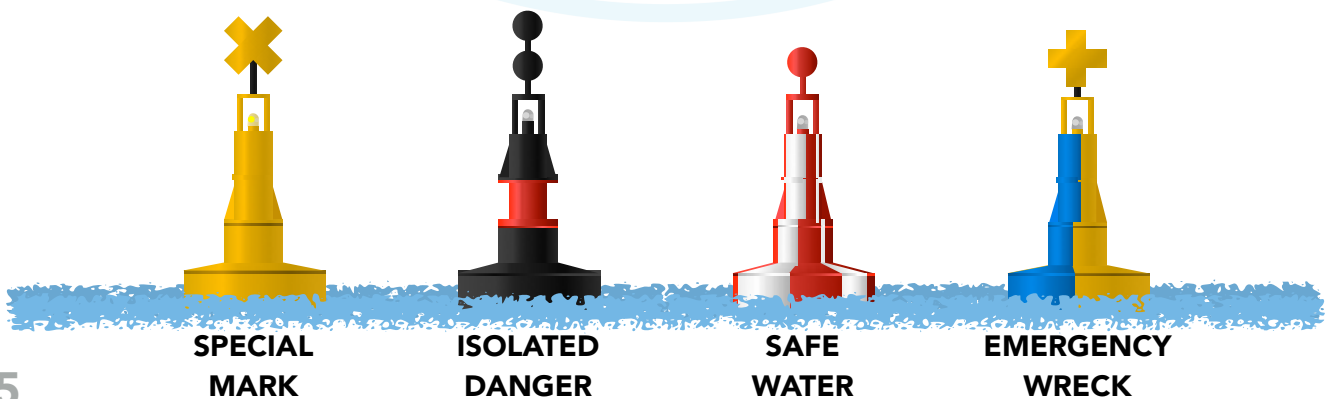
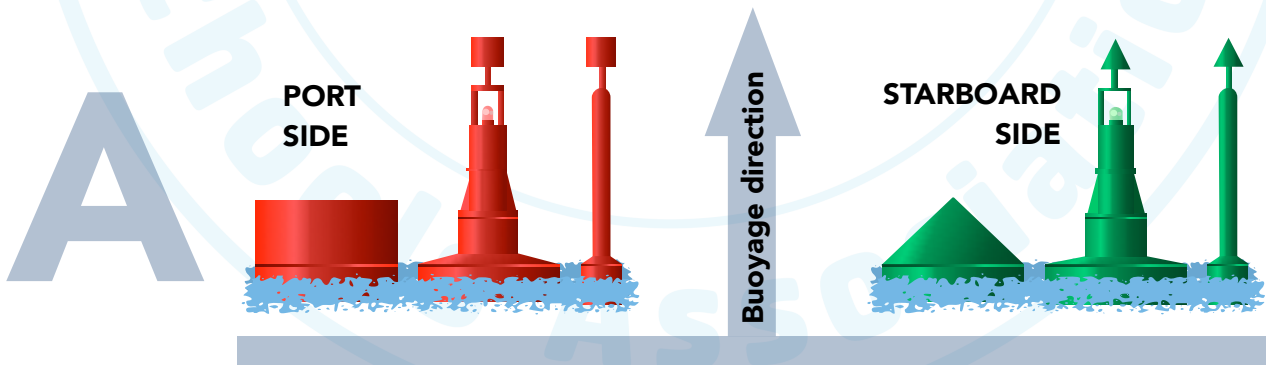

## CARDINAL MARKS

Indicate the direction in which a particular danger lies, and the side on which it is safe to pass.

### For Example:

An West cardinal lies to the west of the danger, and the **clear water is to the west** of the buoy.

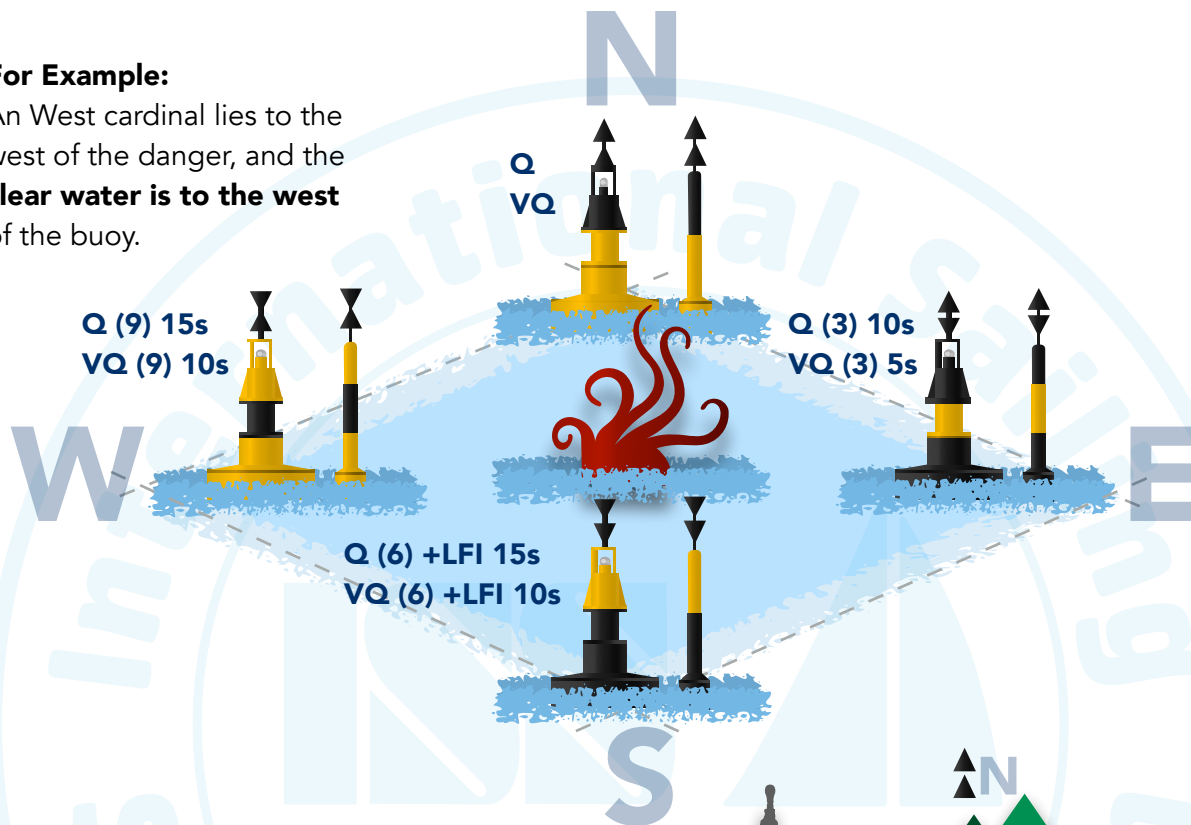

You might use those icons to better memorise the cardinal marks. The icon refer to the arrangement of the cones.

Note that the tips of the cones always indicate the location of the black color on each marker.

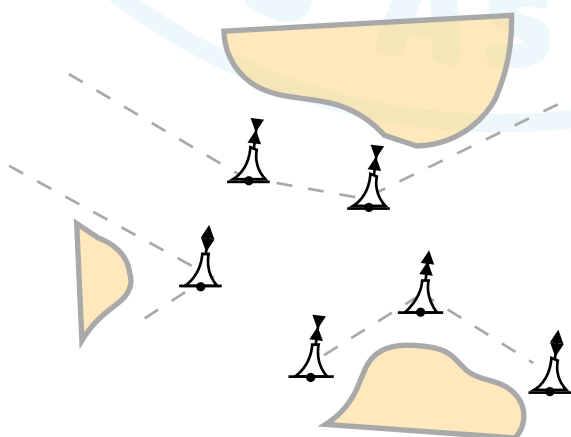
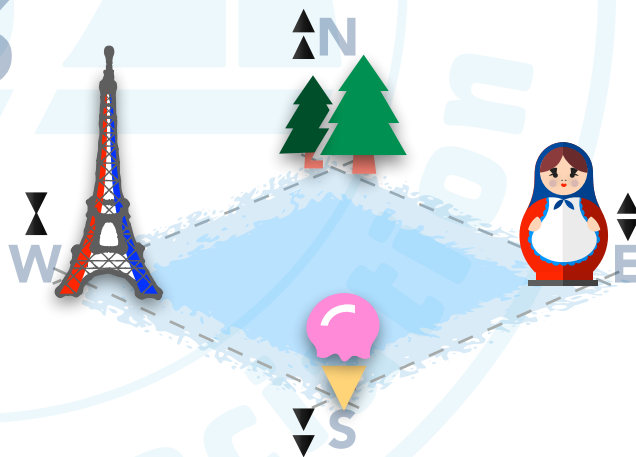

You will **NOT ALWAYS** encounter all **FOUR** marks around the danger zone

## BUOYAGE ON CHARTS

IALA buoys and marks can be found on nautical charts.

They will be labeled with either their light sequence, sound sequence, colour or shape.

## LIGHTS

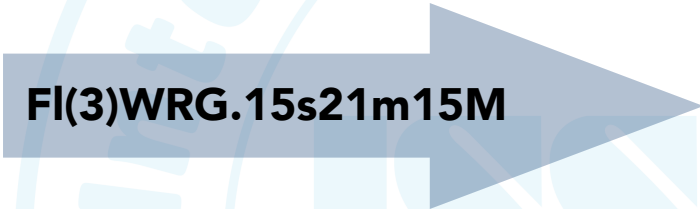
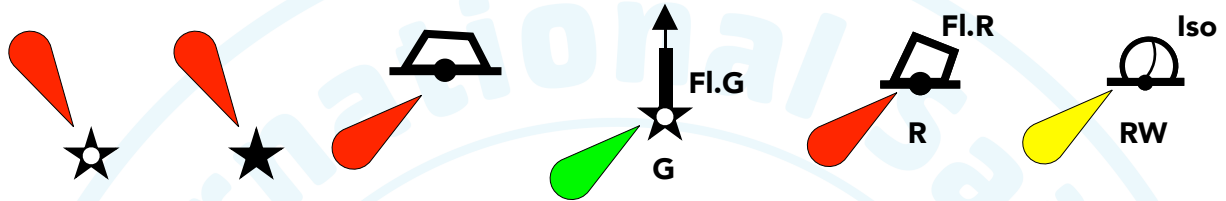

- Flashing groups of 3
- White / Red / Green sectored
- 15 second period
- 21 meters high
- 15 mile nominal visibility

## COLOURS & SHAPES

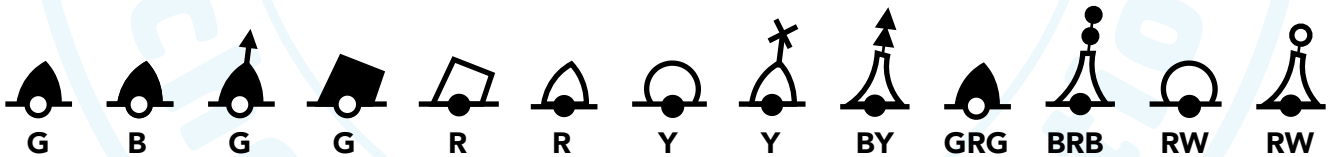

Black | Green | Red | White | Yellow + combinations

## SOUNDS





# IALA Buoyage & Pilotage

You can use a Pilotage Plan to safely enter a harbour, day or night. Each leg can be jotted on a notepad for easy navigation on deck, including the distance and bearing for each leg.

Include in each leg of your plan:

- **Bearing (Compass)**
- **Distance**
- **Dangers and Risks**
- **Buoys (Colour & Number)**

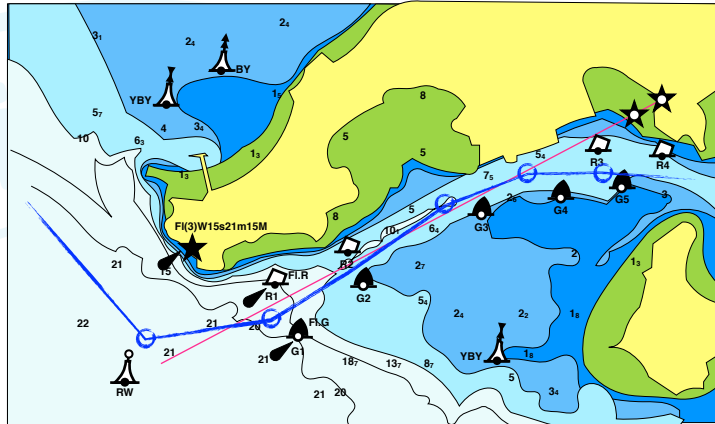

## PREFERRED CHANNEL MARKS

On entering an anchorage, port, harbour or bay there may be more than one route the skipper can take.

IALA have developed **Preferred Channel Markers** to indicate the preferred route into the anchorage.

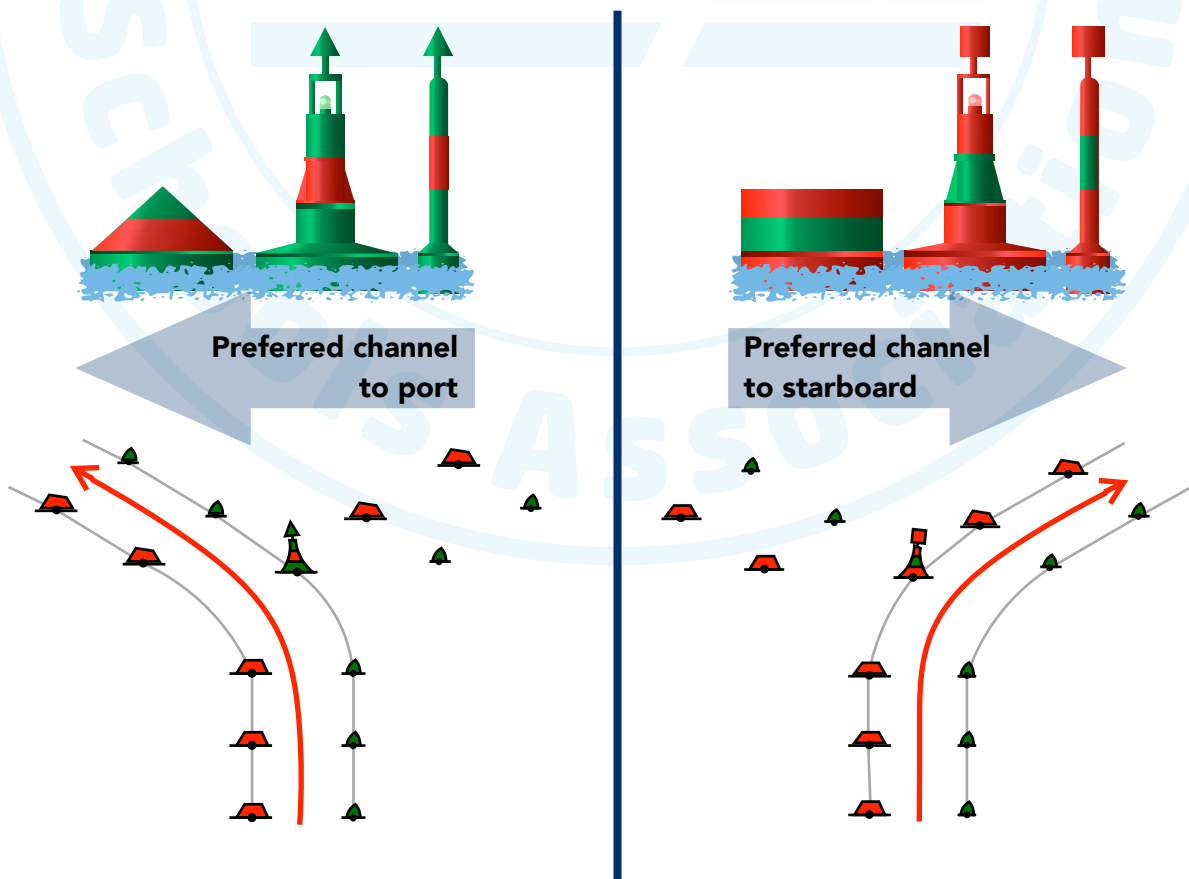

## PILOTAGE - SECTORED LIGHTS

Sectored lights are used as a navigation aid to indicate fairway, a turning point, a junction with other channels, a hazard or something else of importance for the navigator. The light sequence will be shown on the chart, however sectored lights usually consist of a red section, a white section and a green section.

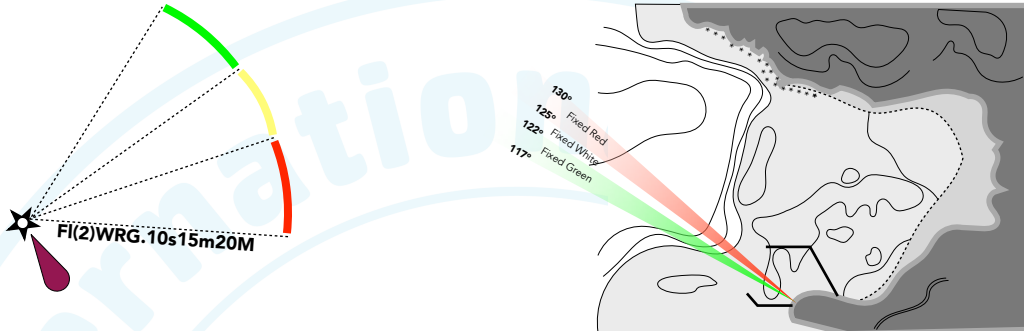

## PILOTAGE - CLEARING BEARINGS

You can use clearing bearing to help you navigate through narrow channels between islands or hazards. To produce clearing bearings we need a prominent point to take two bearings from.

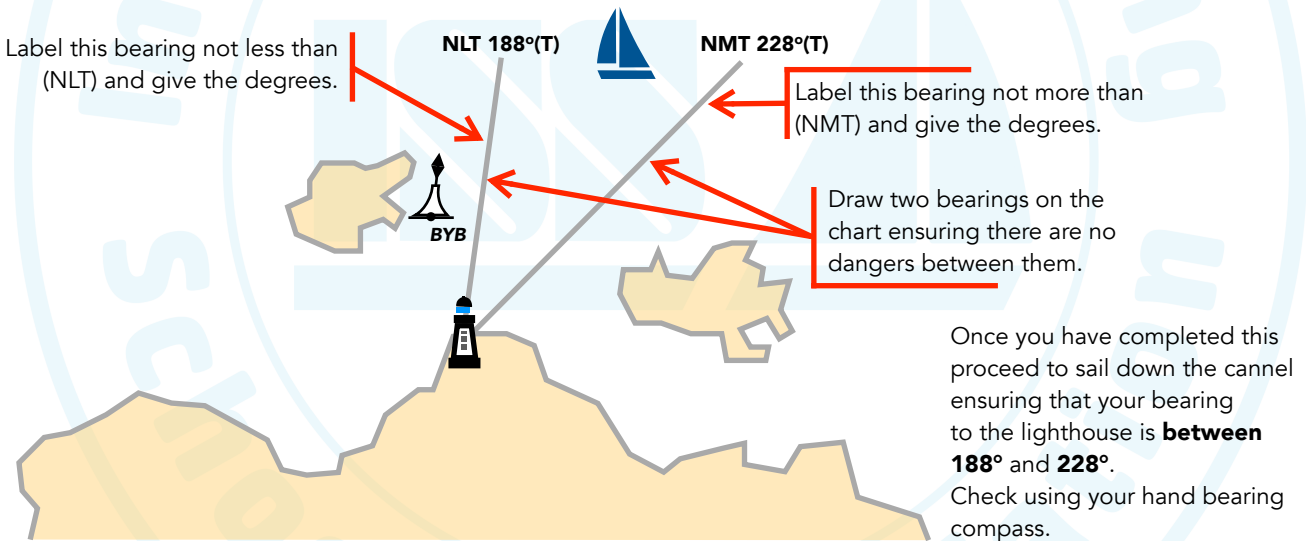

## PILOTAGE - LEADING BEARINGS AND LEADING MARKS

Leading Bearings and Leading Marks are used to guide larger ships up the centre of a channel from the safe water buoy. Leading Bearings will be shown on most charts, and also in smaller pilotage charts in the Almanac.

During the day Leading Marks are large white posts usually with a shape on the top. At night these marks show yellow lights with the sequence shown on the chart.

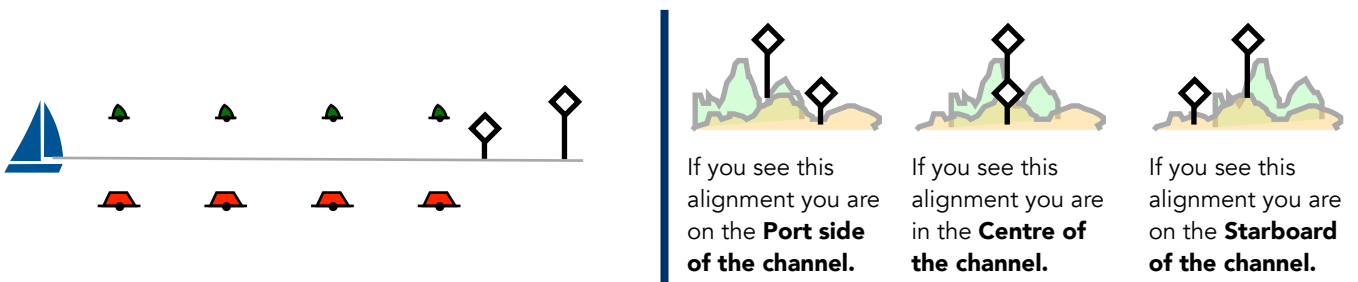

# EXERCISE 2

Sail safely from **A** to **B**, avoiding obstacles marked by the cardinal marks

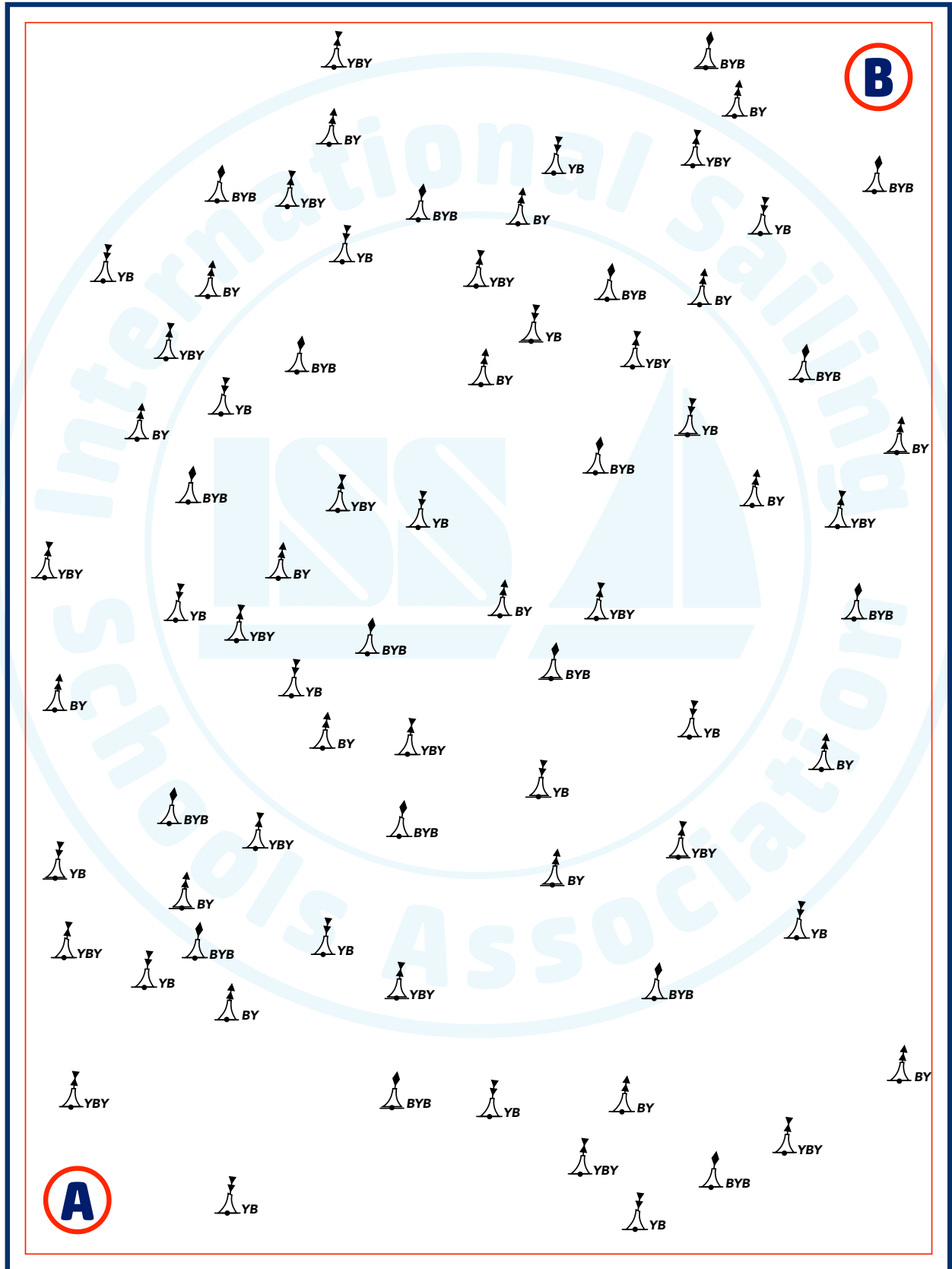

# Meteorology

Inshore Skippers should principally have meteorological information about their local sailing area (coastal sailing). This is mainly the daily forecast, but can also be extended to a week-long, regional or global forecast. In general, the skipper would want information on the following:

- Wind Strength
- Wind Direction
- Precipitation
- Sea State
- Air Pressure
- Temperature
- Cloud Cover
- Seasonal Changes

## WEATHER FORECASTS

Weather forecasts are essential in planning a safe passage. They are available from a variety of sources.

- Internet
  - ▶ windguru.cz
  - ▶ weather4D.com
  - ▶ windy.com
  - ▶ GRIB Files
- Navionics™
- Local Radio
- National Radio (Shipping forecast)
- Marina Office
- Appropriate National Meteorological Offices
- INMARSAT
- NAVTEXT



**GRIB FILES** are the standard data format of the World Meteorological Organization. They are available to download and contain raw data based on the world's collected meteorological information.

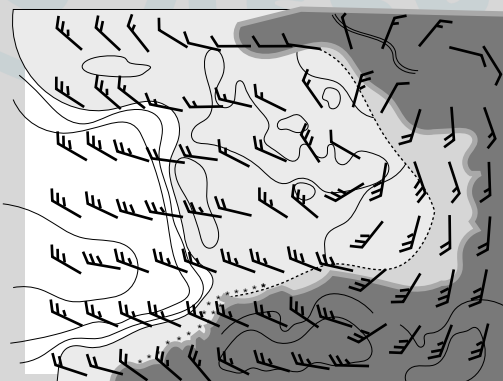

The direction of the arrows corresponds to the direction of the wind.

- = 5kn
- = 10kn
- = 15kn
- = 20kn

## FORMAT OF SHIPPING FORECAST

Shipping forecasts are issued daily by the UK MET Office at: [www.metoffice.gov.uk/public/weather/marine](http://www.metoffice.gov.uk/public/weather/marine) and broadcast on BBC Radio 4 and other local, mainly national radio stations, usually few times a day. They use a specific format and terminology that skippers should know. The information is most commonly issued in the following order:

1. Gale Warning,
2. General Synopsis,
3. Sea Area Forecasts
4. Weather – Wind – Visibility
5. Coastal Station Reports
6. Wind
7. Significant Weather
8. Visibility in miles or meters
9. Pressure
10. Tendency

## TERMS USED IN THE FORECAST

### WIND

**Veering Wind:** Wind is changing its direction and is moving clockwise from 0°.

**Backing Wind:** Wind is changing its direction and is moving anti-clockwise from 359°.

**Cyclonic:** Considerable change in wind direction as a depression passes through an area.

### TIME

**Imminent:** Within 6 hours from the time of issue.

**Soon:** Between 6-12 hours from the time of issue.

**Later:** More than 12 hours from the time of issue

### VISIBILITY

**Good:** More than 5 miles.

**Moderate:** Between 2-5 miles.

**Poor:** Between ½ mile – 2 miles.

**Fog:** Less than 1000m.

### SEA STATE

**Smooth:** Wave height is less than 0.5m.

**Slight:** Wave height is between 0.5m – 1.25m.

**Moderate:** Wave height is between 1.25 – 2.5m.

**Rough:** Wave height is between 2.5m – 4m.

**Very Rough:** Wave height is greater than 4m.

## CORIOLIS EFFECT / GLOBAL WIND PATTERNS

The Earth is constantly rotating about its own axis, completing one revolution in 24 hours. This spinning causes anything which moves freely over the Earth's surface to be deflected to the right of its path in the northern hemisphere and to the left in the Southern hemisphere

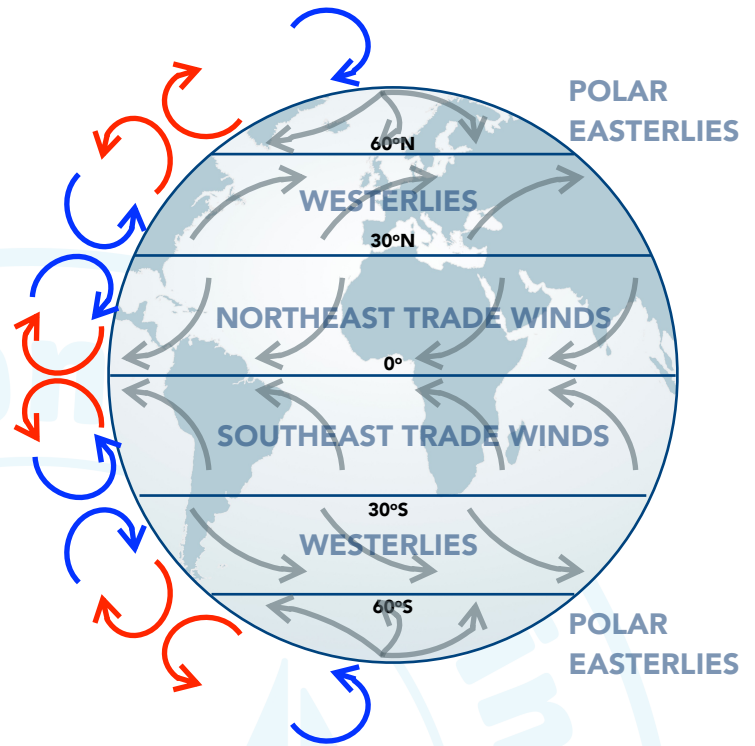
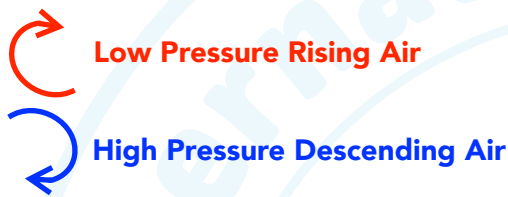

## SYNOPTIC CHARTS

Synoptic charts are maps overlaid with meteorological information pertaining to air pressure and fronts. Lines of equal air pressure (isobars) indicate areas of high or low pressure, whilst red lines indicate warm fronts and blue lines indicate cold fronts.

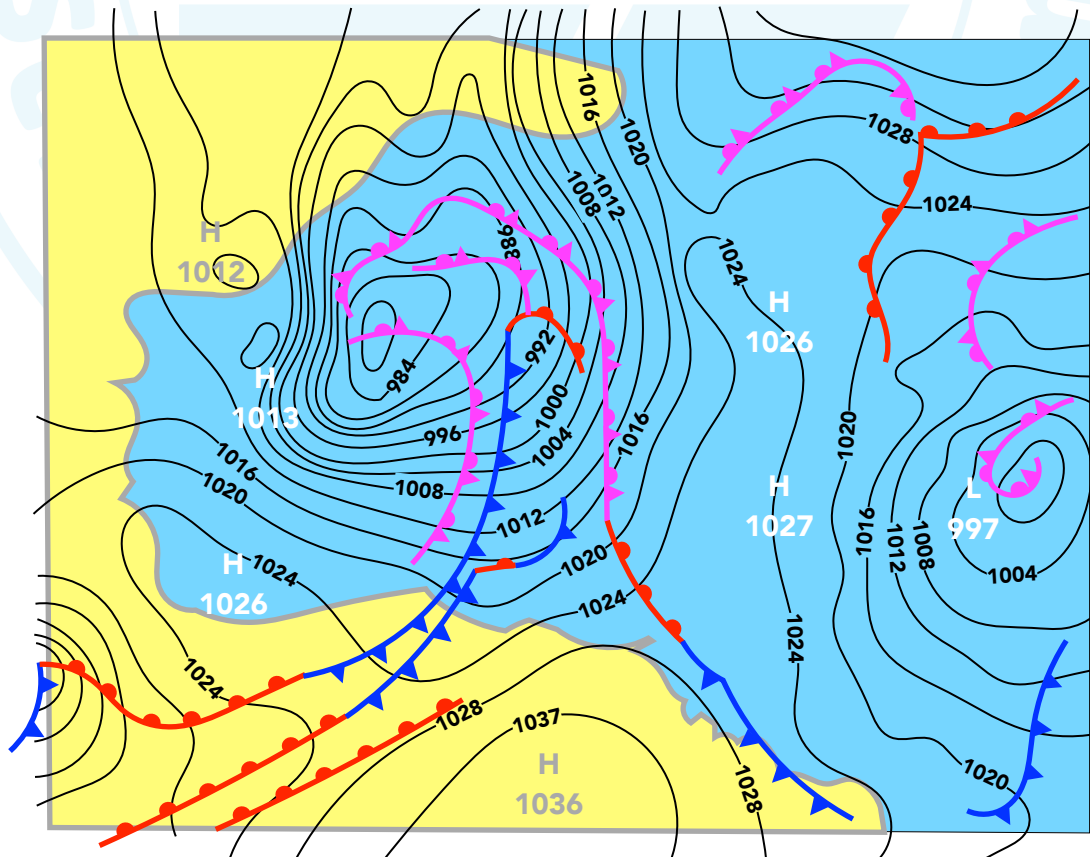

## FORMATION OF A DEPRESSION

Changes in weather are caused by the interaction of cold and hot air masses.

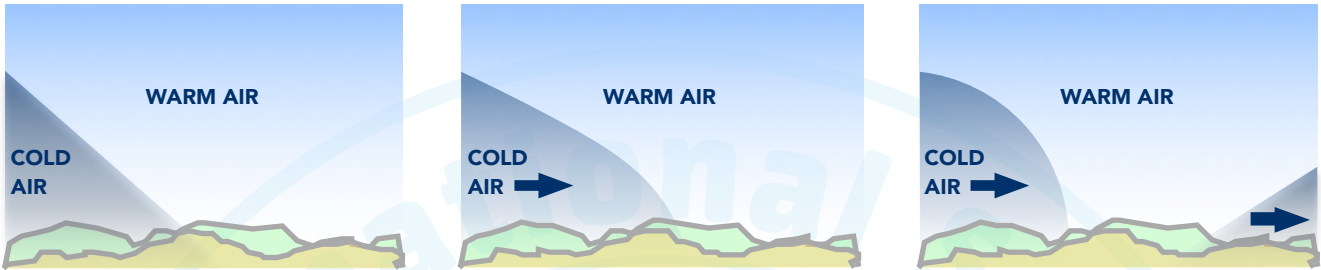

When they meet they do not mix. The cold air moves below the hot air as it is denser.

As the cold front advances it undercuts the hot air, moving it towards the centre of the depression.

The cold front moves quicker than the warm front and will soon develop into an occluded front.

Viewed from above, the development of a front looks like this:

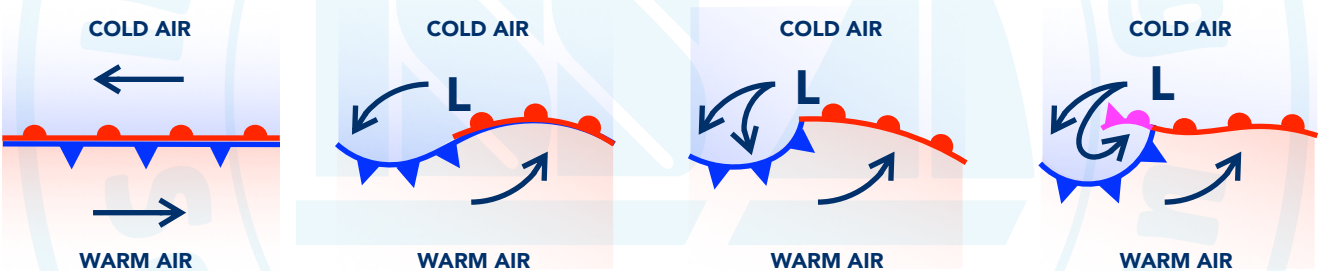

The rotation of the earth causes depressions to develop in a counter-clockwise fashion in the Northern Hemisphere

## TYPES OF CLOUDS

Clouds are formed by the condensation of water in the atmosphere.

The height of cloud determines its shape and its risk of precipitation.

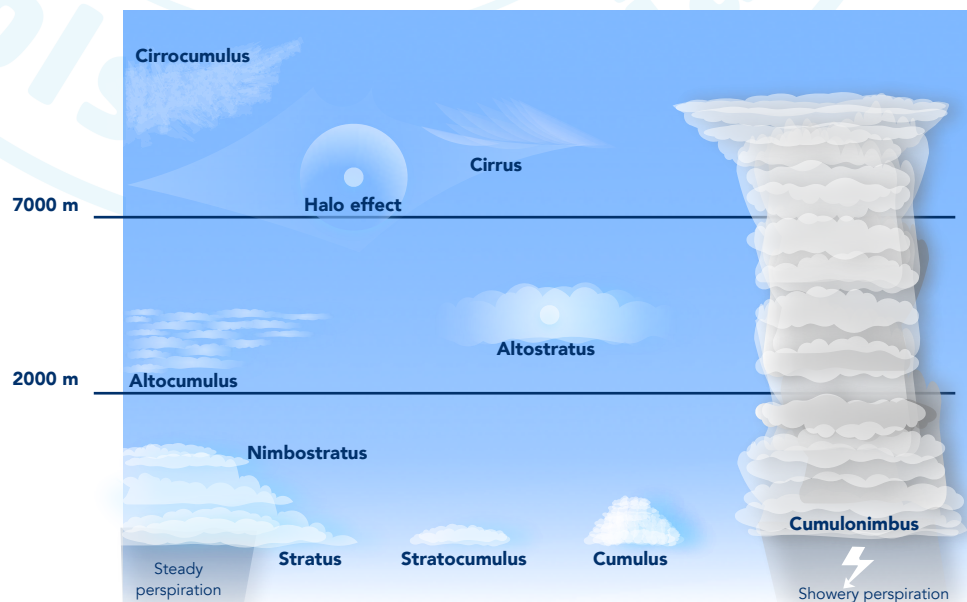

## BEAUFORT SCALE

Beaufort scale is an empirical measure that relates wind speed to observed conditions at sea or on land.

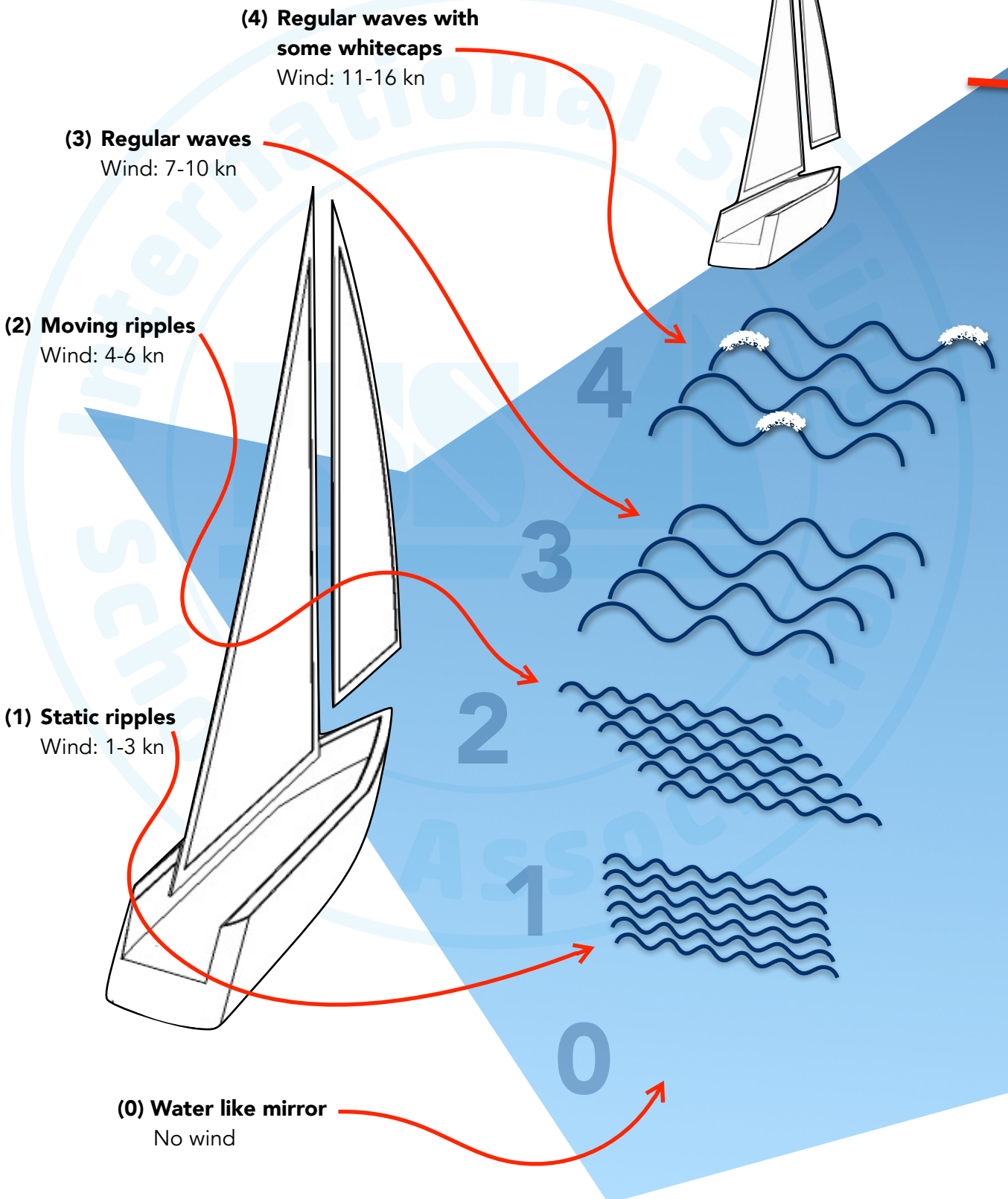



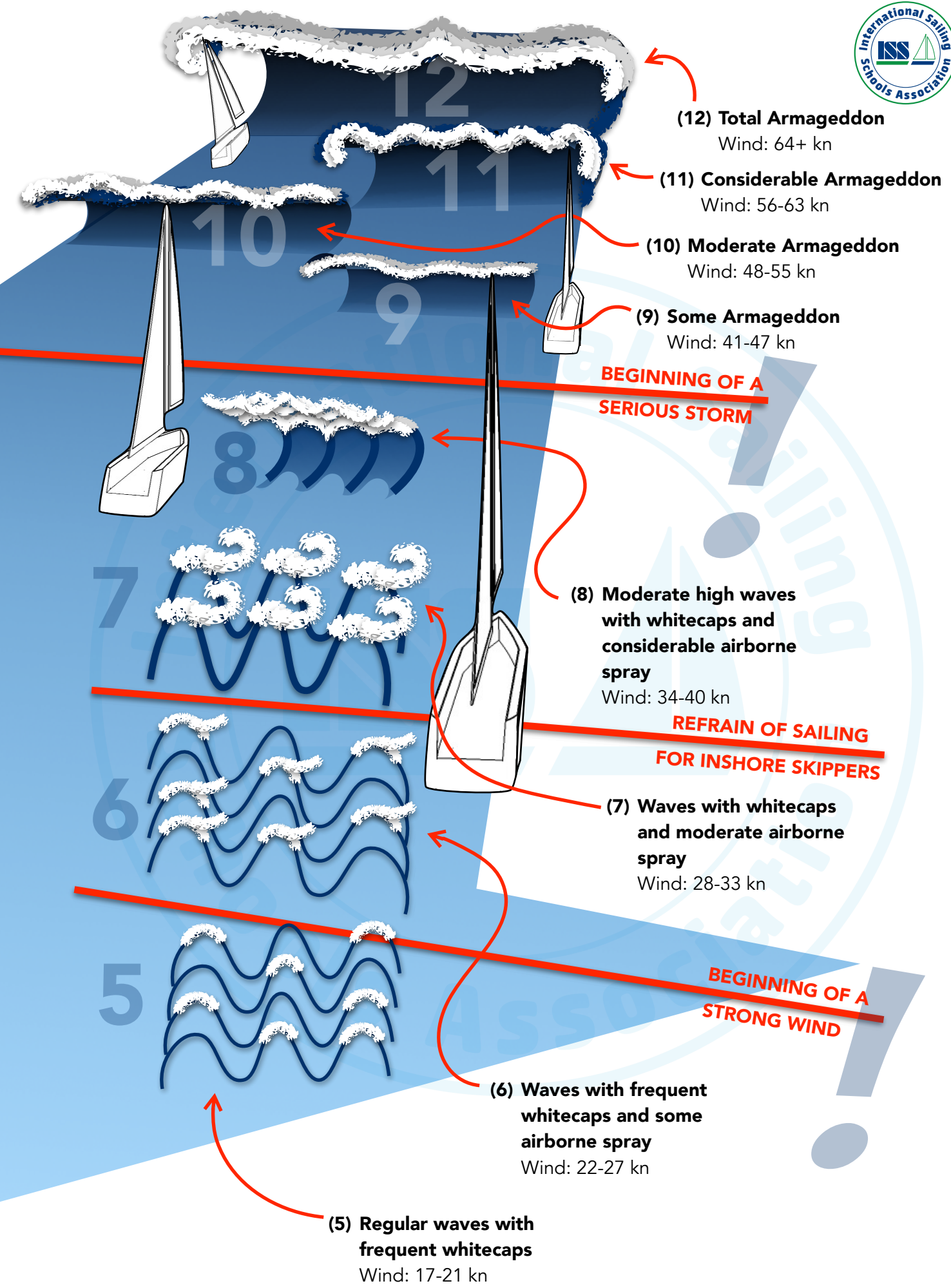

# Handling Yacht Under Sails

## POINTS OF SAIL

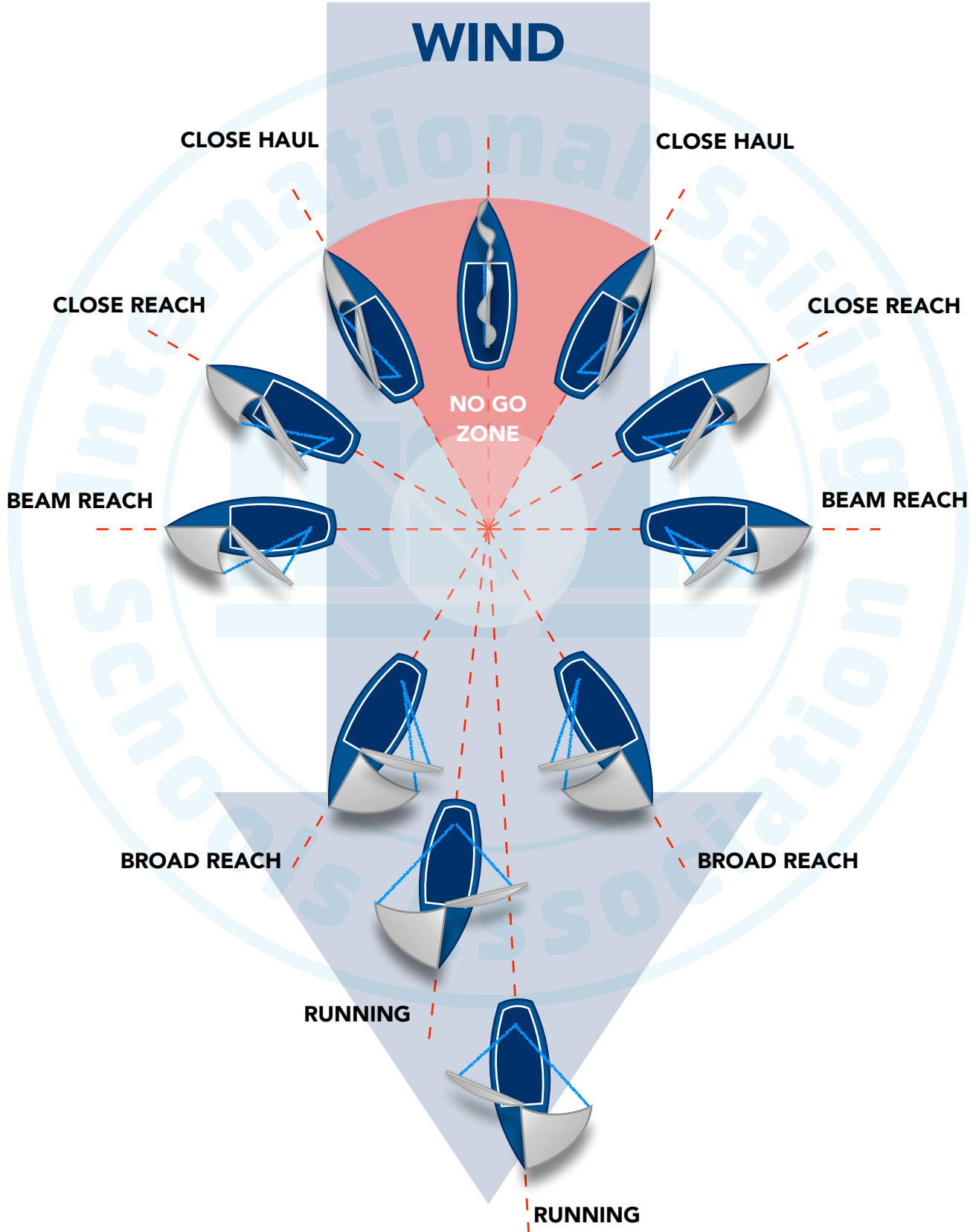

### LUFF UP

Steer to reduce the angle between boat's heading and the direction the wind is coming from. Winch the sheets of both sails, first of all the main sail, as it is the "back" sail that makes the boat turn to the wind.

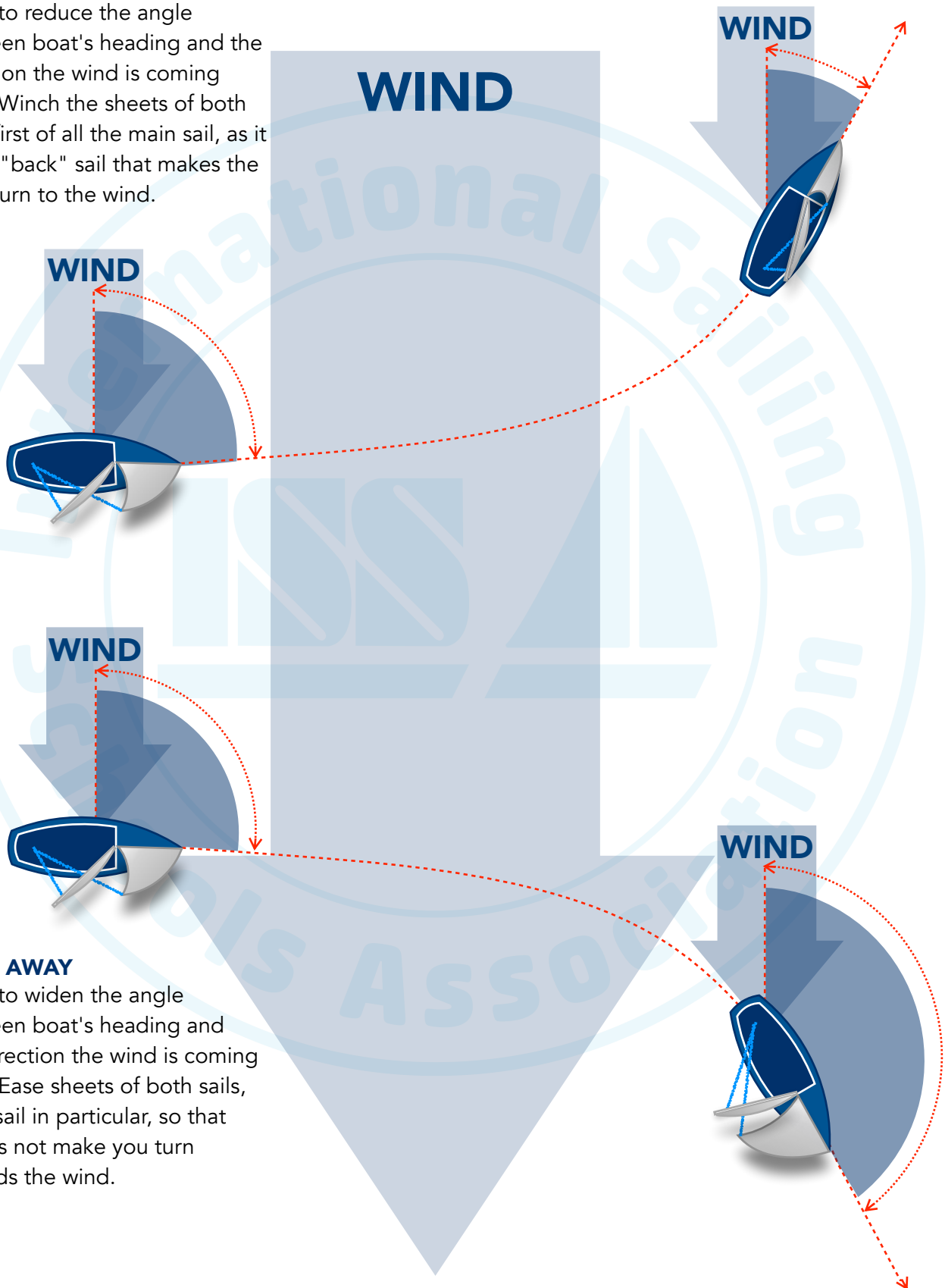

### BEAR AWAY

Steer to widen the angle between boat's heading and the direction the wind is coming from. Ease sheets of both sails, main sail in particular, so that it does not make you turn towards the wind.

## TACKING

## GYBING

3

1

When you pass the "No go zone" the mainsail fills up with wind. Straighten the tiller and winch in the other tack jib sheet

To start the maneuver turn the tiller gently and winch in the main sail sheet quickly to bring the boom as close to the boat's centre line as possible

2

2

Once you enter the "No go zone" let go of the working jib's sheet. No need to adjust the mainsail sheet.

Keep the tiller slightly turned. Once you pass the wind line, pull the other tack jib sheet gradually while slowly releasing the initial tack jib sheet. Release the main sail sheet to its working position

1

3

Sufficient speed is crucial for the maneuver. You might need to bear away a bit to gain it. When ready turn the boat's tiller distinctively - at least 30 degrees

Straighten up the tiller. Trim the sails. It might be wise to install a preventer

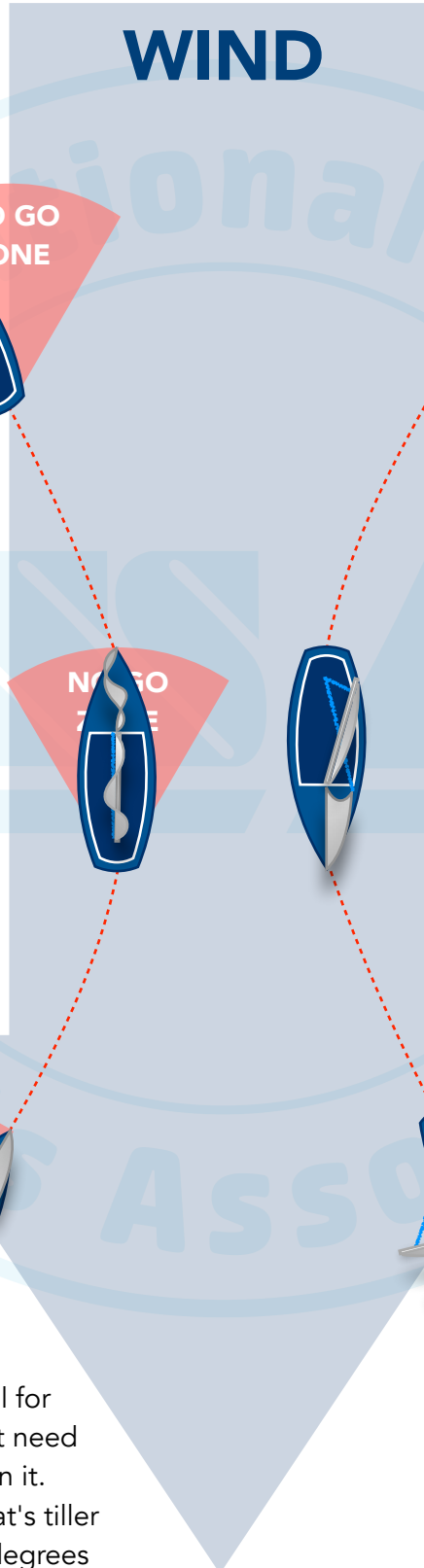

# Handling Yacht Under Sails

## DANGEROUS GYBE

It is crucial to control the main sail sheet. **The boom should be brought to the boat's centre as close as possible before the boat passes to the other tack zone**, leaving the boom as little room as possible to gain momentum.

If the boom is away from the boat's center, when crossing the wind line, it turns into a doom tool. It will fly violently to the other tack zone putting a lot of dynamic tension on boat's construction (main sail sheet, shrouds, boom fixing points)

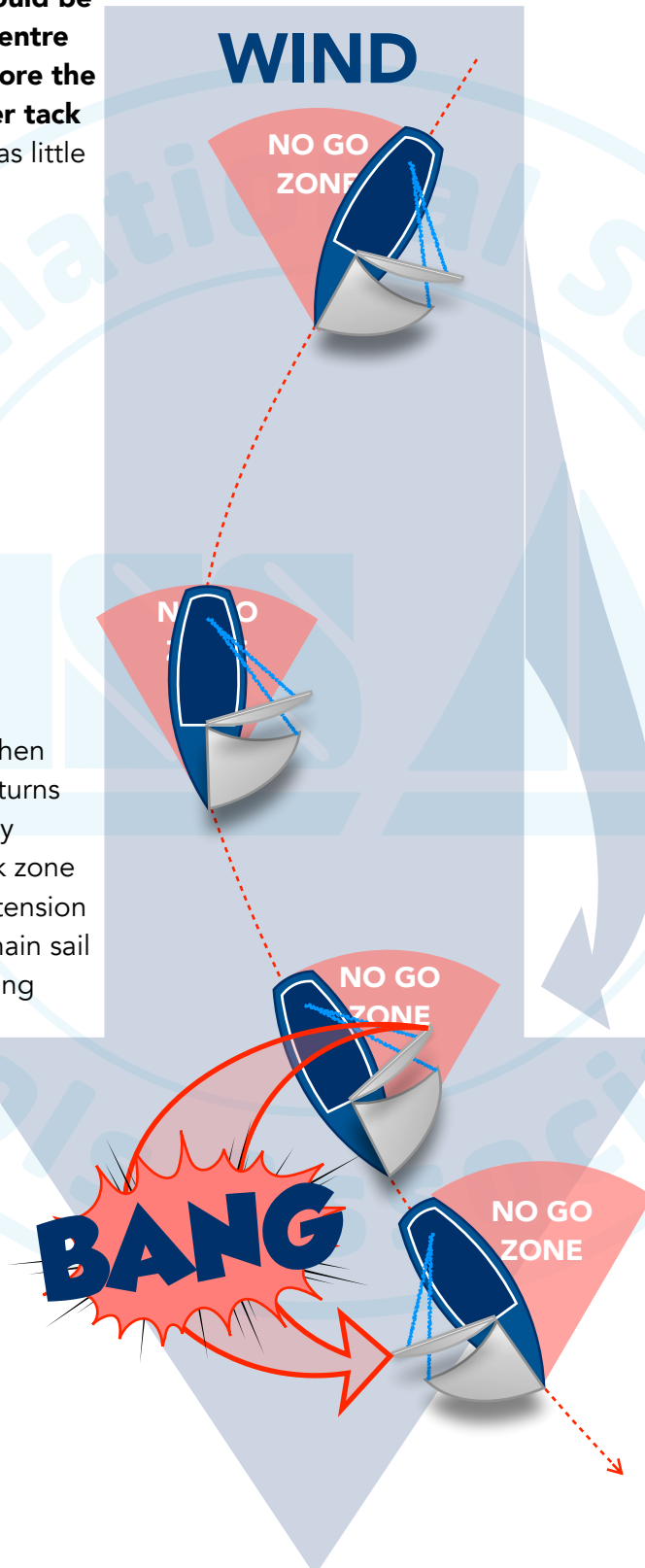

# Handling Yacht Under Power

## GEARS

Most of the modern boats are equipped with a shifter like the one below. You always **start the engine on neutral** and then you can switch to forward or reverse. Moving the shifter further in each direction is like pushing the accelerator pedal in a car. **There is no break** however!

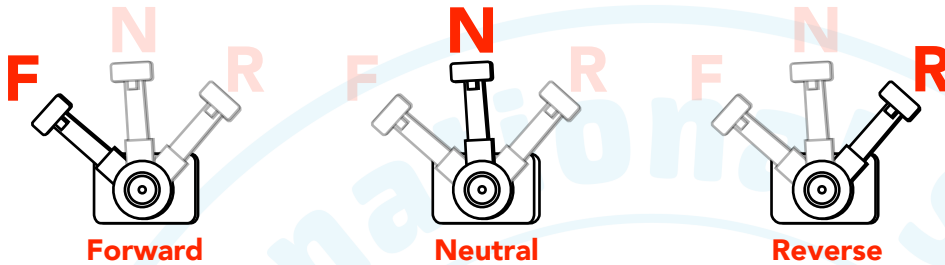

Always allow a **moment in neutral** when switching gears.

## INERTIA

The behaviour of the boat on the water resembles ice skating a little. The boat will never stop at once. It also won't turn so precisely as a car.



Always bear in mind that the **boat is heavy** and has **a lot of inertia**.

## PROP KICK

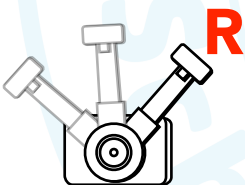

Only appears when you are in reverse gear.

Always **check the direction** your propeller revolves.

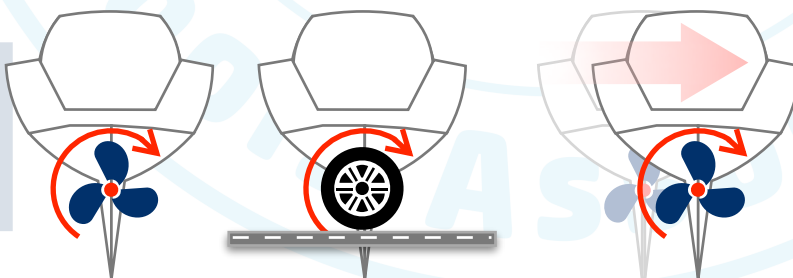

If propeller revolves clockwise, the stern will move to starboard before going into reverse.

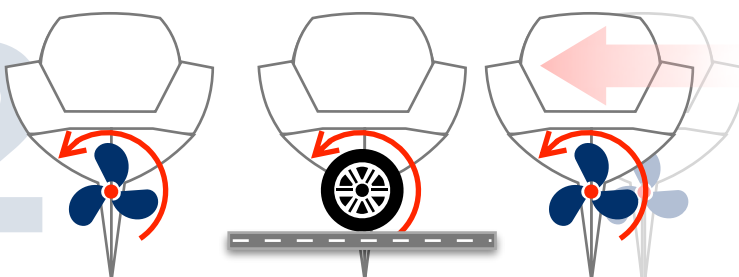

If propeller revolves counterclockwise, the stern will move to port before going into reverse.

## TURNING CAPABILITY - THE HEART RULE

Wind and stream play a strong factor in the boat turning capability .

### WIND

When head-to-wind, the bow will easily come around

**Pivot points** are different for every boat, but when **going ahead** a yacht usually pivots around a point approximately **1/3 from the bow** (roughly at the mast). When **going backwards** the pivot point moves **1/3 from the stern**.



When going downwind, the wind will resist your efforts to make a turn

**The bow is most vulnerable to the wind**

When going **forward**, beware of colliding with obstructions **with your stern**

When going **backward**, beware of colliding with obstructions **with your bow**

## DOCK LINES

Each line used for docking a boat has a different function.

**Bow line & stern line** are the main docking lines. They keep the boat from running away from the dock but **DO NOT STOP the boat's FORWARD and BACKWARD** movement

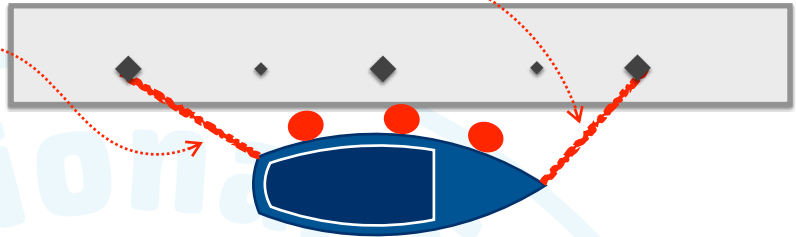

**Bow spring & stern spring**

are additional docking lines. They keep the boat from moving forward and backward. Always use them when leaving the boat longer at the dock

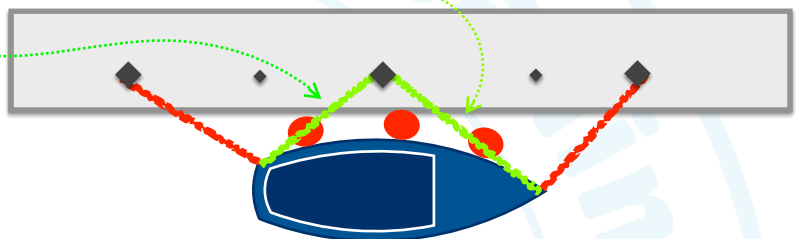

**Bow breast & stern breast**

keep the bow and stern close alongside, particularly in case of a strong offshore wind. They are not essential when bow and stern lines and springs are also used.

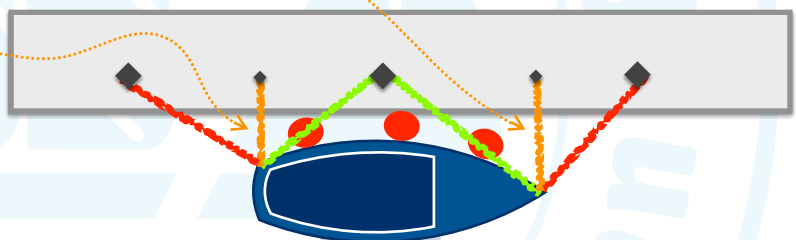

**WIND**

## FENDERS

Fenders are usually made of plastic and are hung from the **grab-rails** or lifelines over the side of the boat to prevent it making contact with the bulkhead, dock or another boat along side. They are made in a variety of shapes to suit different situations. You should use at least three fenders when berthed alongside.

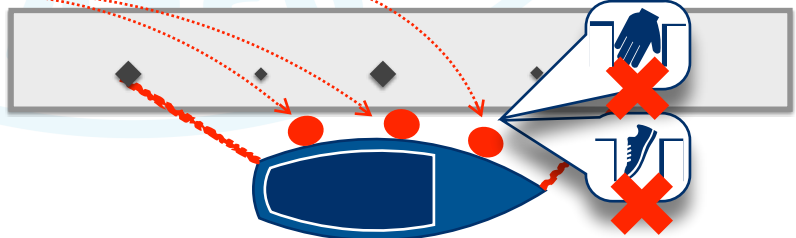
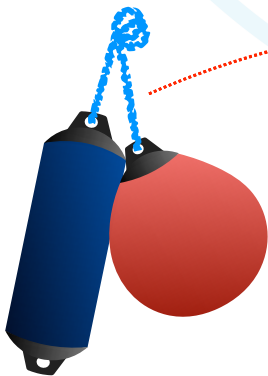

**NEVER** twist the fender rope around your hand when handling fenders.

**NEVER** Use your hands or feet to push away the boat from the bulkhead.



## TYPES OF BERTHS

### ALONGSIDE

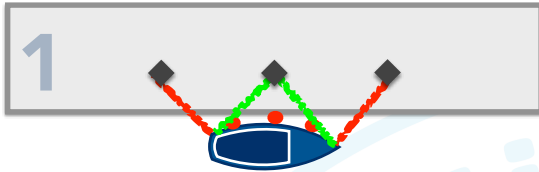

The most typical type of berth. Use at least bow and stern line. Adding just one spring line will better stabilize the boat.

### DOLPHINES

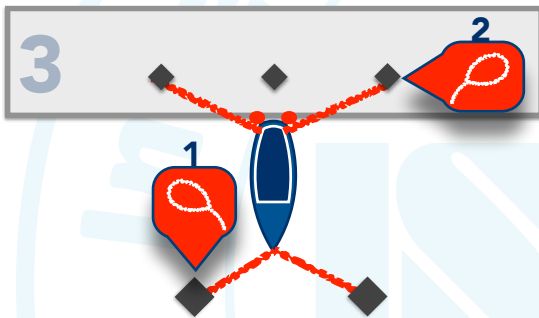

In some marinas you might encounter docking piles, called dolphins (large wooden or metal stakes driven into the seabed). When approaching the berth first fix the lines on the piles and then ashore.

### MOORINGS

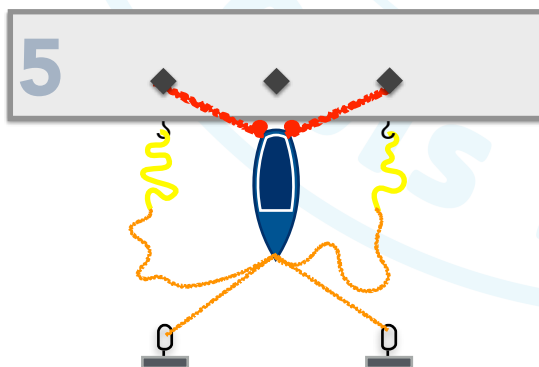

Usually there is a lazy-line secured to an underwater mooring. The lazy-line is **picked up from the shore side** on arrival and **led to bow (or stern, depending on how you want to dock) and fixed from the open water side**. Twin moorings secure the boat.

### BOW/STERN

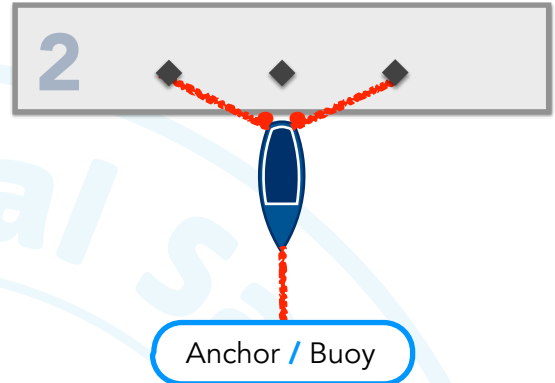

To berth with your bow or stern you will need to attach the boat to the docking buoy (if there is one) or to use your anchor to stabilize the boat.

### FLOATING DOCK

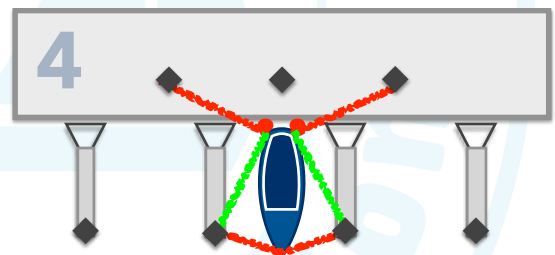

Modern marinas offer platforms or ramp supported by pontoons that are called floating docks. They allow a convenient berth. ramps are usually shorter than the boats. Use spring in order to prevent the boat of hitting the bulkhead.

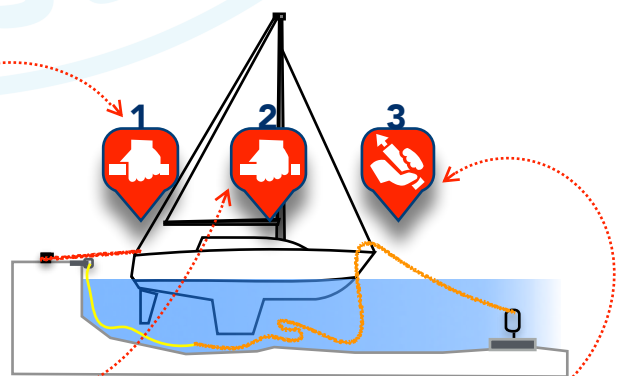

## LEAVING THE DOCK



- (1) Remove all lines except the **stern line**.
- (2) The bow will be blown away.
- (3) When clear, **shift forward** and remove the stern line.



- (1) Move a **fender to stern** and remove all lines except the stern spring.
- (2) **Turn** as if You wanted **to leave** (steering wheel to starboard), **go into reverse** and wait for the stern to reach 45-60 degrees from the dock.
- (3) **Engage neutral**. Wait, adjust the steer for going reverse
- (4) **Engage reverse** and back off at possibly slow speed (depending on tide and wind).



- (1) Move a **fender to bow** and remove all lines except the **bow spring**.
- (2) **Turn** the boat as if You wanted **to hit the dock** (steering wheel to port), **shift forward** and wait for the stern to be put away.
- (3) **Engage neutral**. Prepare the steer for reverse gear.
- (4) **Remove the bow spring and go reverse**. Bear in mind the prop kick.



- (1) Move a **fender to bow** and remove all lines except the **bow spring**.
- (2) **Turn** the boat as if You wanted **to hit the dock** (steering wheel to port), **shift forward** and wait for the stern to be perpendicular to the dock.
- (3) perpendicular to the dock.
- (4) Remove the bow spring and **go into reverse as far as possible**. Bear in mind the prop kick.

# Handling Yacht Under Power

## ARRIVAL AT THE DOCK

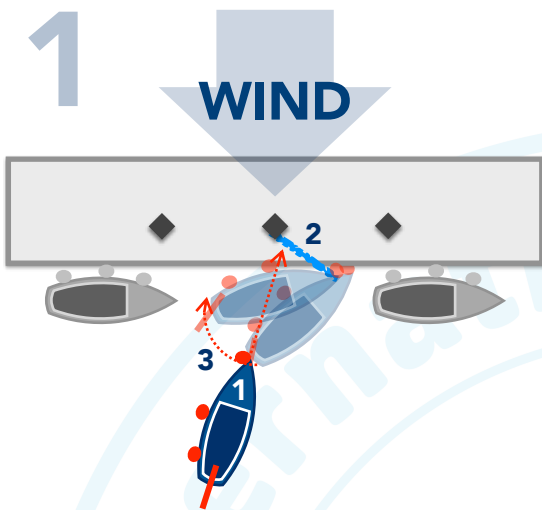

- (1) Come into the dock on a **wide angle**, **targeting the middle of the spot** to berth, watch your speed and move a **fender to the bow**.
- (2) **Fix the bow spring.**
- (3) **Turn** as much as possible **to starboard**. Keep the **forward** gear. Wait for the stern to approach the deck.

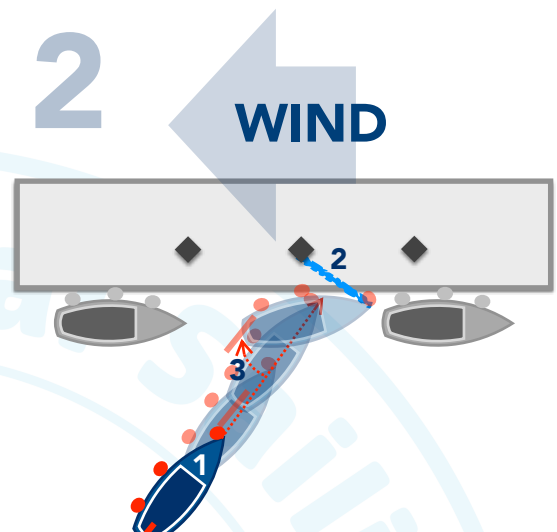

- (1) Come **into** the dock on a **gentle angle**, **targeting ahead** the spot to berth, watch your speed and move a **fender to the bow**.
- (2) **Fix the bow spring.**
- (3) **Turn** as much as possible **to starboard**. Keep the **forward** gear. Wait for the stern to approach the deck.

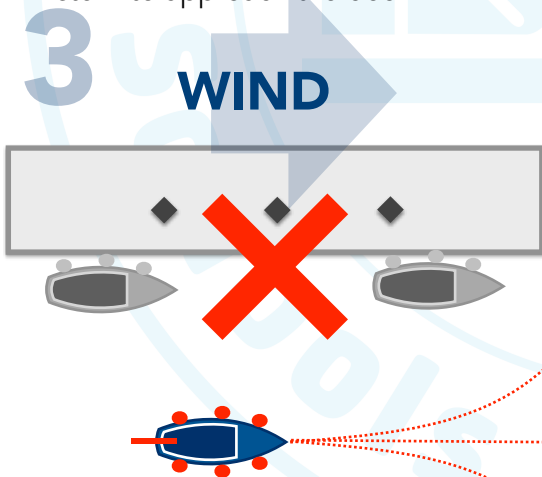

- **Avoid berthing with wind behind you** and carefully look for some other place in the marina.
- Or **alternatively** you can **turn the boat around** and approach the berth.
- When approaching the marina prepare your **fenders on both sides** of the boat.
- Move slowly and **make a reconnaissance**.
- You don't have to dock at once. It's not a race.

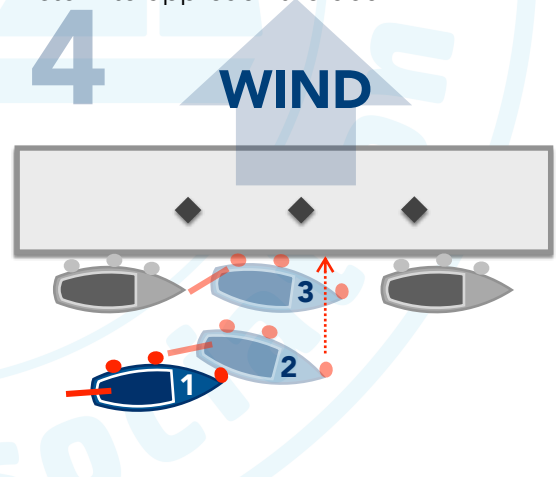

- (1) **Approach** the dock at a gentle angle, moving **almost parallel to the berth**.
- (2) **Stop** in the front of the place selected for berth **with the bow a bit to the wind**.
- (3) **Wait** until the **wind pushes the boat** into the berth.

# Anchoring

## TYPES OF ANCHORS

There is a number of different types of anchors and each has its own advantages and disadvantages. Below the most common types you might encounter:



**Bruce:** Universal, but poorly keeps on clay and heavy mud.



**Fisherman's:** It holds well on the rocks, but it is difficult to store.



**Delta:** Holds well on most substrates. Weaker only on the rocks.



**Danforth's:** Holds well on the sand and in the mud. It occupies little space.



**Mushroom:** Good for long-term anchoring

## CHOOSING THE RIGHT SPOT

Choosing the right spot for anchoring is crucial. Check your chart for proper depths, anchoring sites and type of substrate on the bottom.

Always check the **unit of measurement (meters or feet)** for each chart.

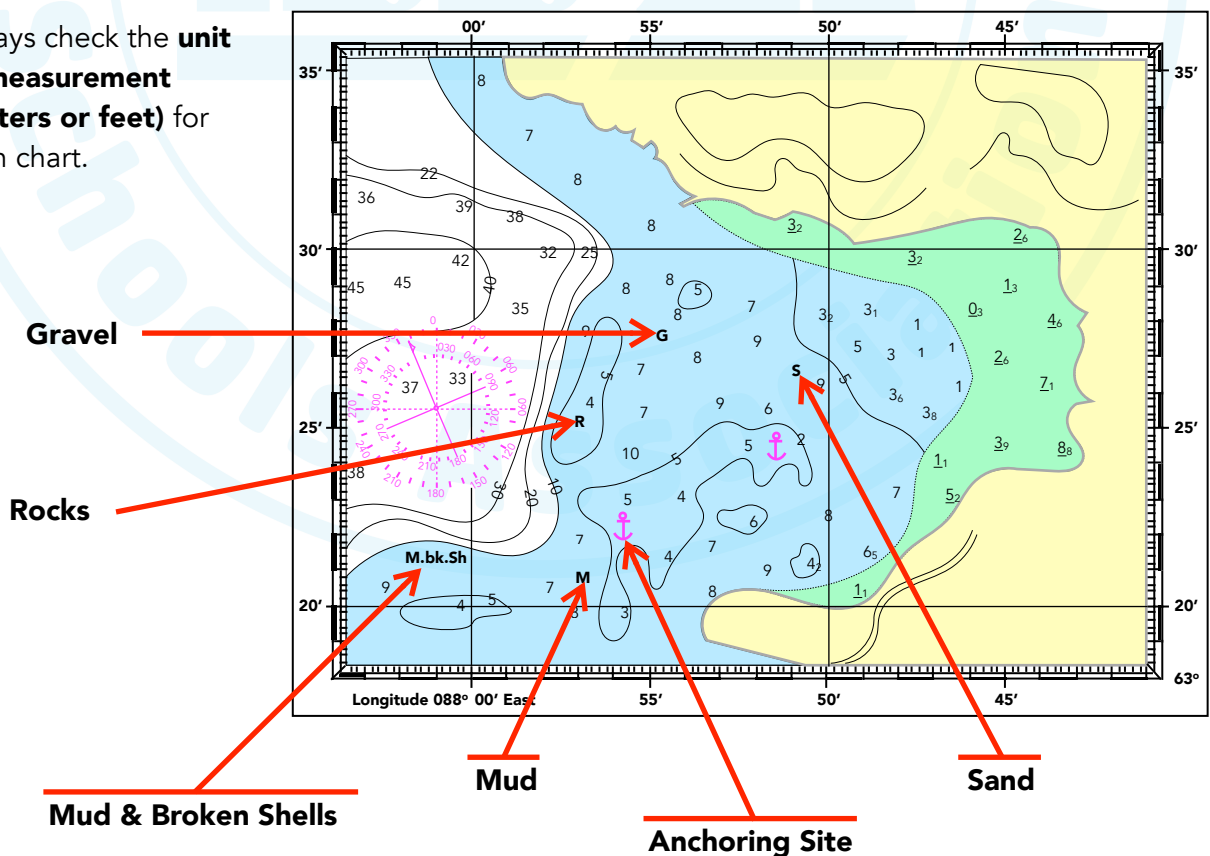

### DROPPING THE ANCHOR

Look at how other boats are oriented on the approach to the site. (1) Always go against the wind when dropping an anchor. (2) Ensure you have stopped. (3) Start easing the anchor. (4) Go slowly backwards, (5) until the chain/rope stretches.

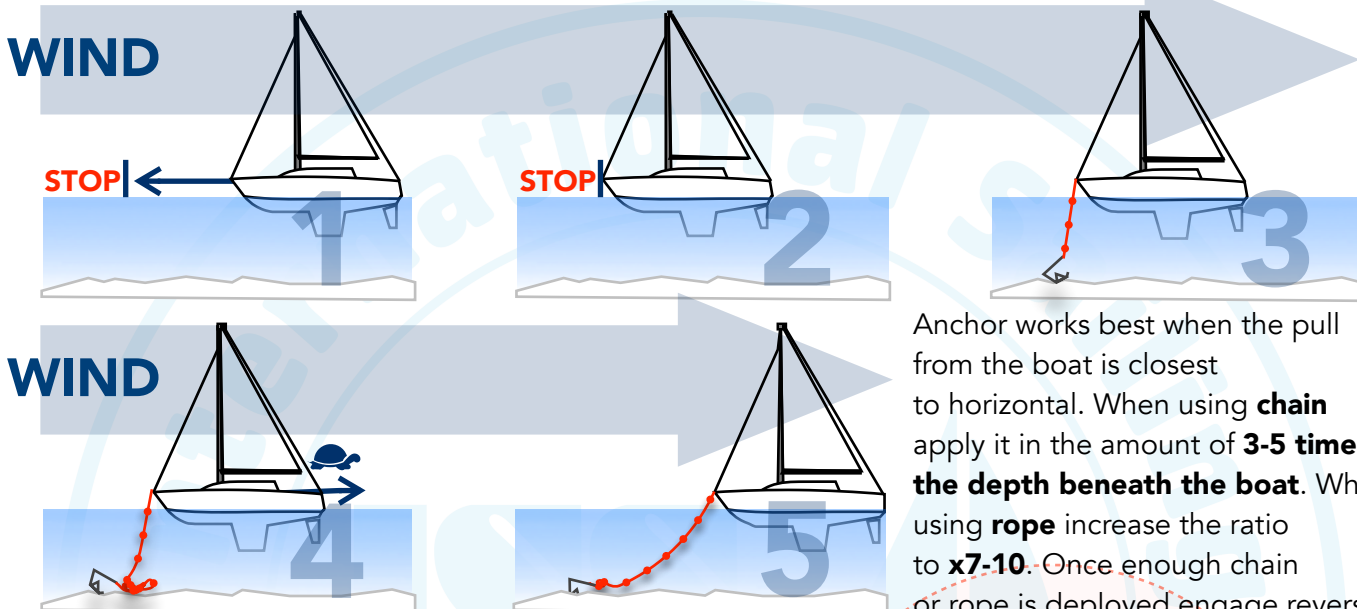

Anchor works best when the pull from the boat is closest to horizontal. When using **chain** apply it in the amount of **3-5 times the depth beneath the boat**. When using **rope** increase the ratio to **x7-10**. Once enough chain or rope is deployed engage reverse gear and with high revs for 2-3 seconds, check if the anchor holds well.

### SWINGING CIRCLE

Bear in mind the swinging circle, which is around one third of the part of chain or rope that is laying on the seabed. Ensure your **swinging range clears obstructions**. In order to check if the anchor is holding observe your swing. **Keep in mind the possible change in wind direction.**

**WIND**

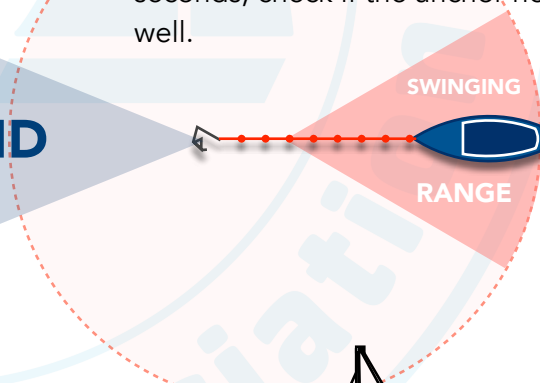

### RAISING THE ANCHOR

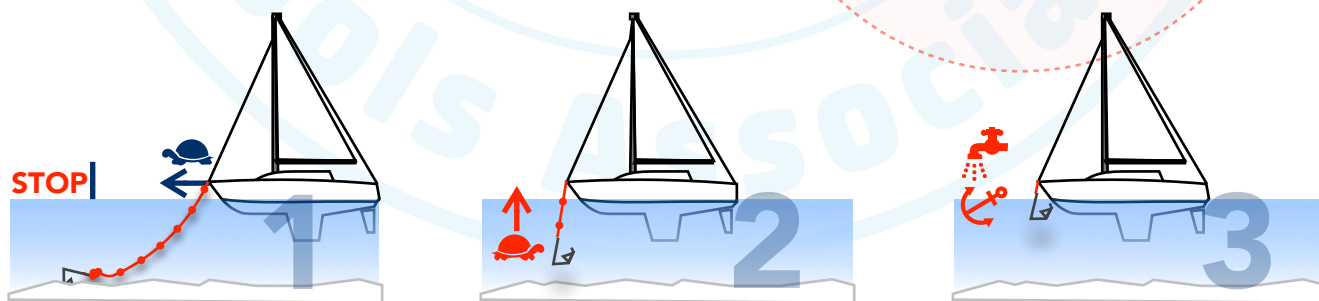

(1) Slowly move towards the anchor. **Watch for the chain/rope not to get beneath the hull.** (2) When near vertically above, start pulling the anchor. (3) Rinse it and carefully get in aboard. (4) Secure the anchor aboard and you are free to go.

# IRPCS

The **International Regulations for Preventing Collisions at Sea 1972 (COLREGS)** are published by the International Maritime Organisation (the IMO) and set out, among other things, the "rules of the road" or navigation rules to be followed by ships and other vessels at sea to prevent collisions between two or more vessels.

## FUNDAMENTAL RULES

- 1 **KEEP A WATCH** by all appropriate means (look, listen, radar, AIS)
- 2 **NO ONE** has '**RIGHT OF WAY**'
- 3 One vessel is the give way, the other is the stand on vessel.  
3 **BOTH** remain **RESPONSIBLE** to avoid a collision
- 4 Travel at a **SAFE SPEED** for the conditions
- 5 In a narrow channel **KEEP TO STARBOARD** (right)
- 6 **GIVE WAY** = **EARLY & SUBSTANTIAL** action
- 7 **STAND ON** = **MAINTAIN COURSE AND SPEED** until it is clear the other vessel is not taking action and only then take avoiding action

## RISK OF COLLISION

When there is deemed to be a risk of collision

- One vessel is the **GIVE WAY** vessel
- The other is the **STAND ON** vessel

If there is a **CONSTANT BEARING** between the two vessels which are approaching each other there is a risk of collision.

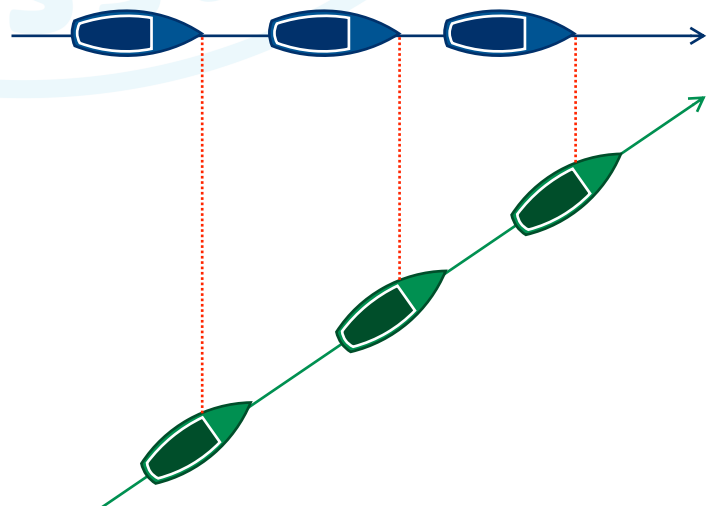

## SAILING RULES

### UNDER SAIL



#### Starboard Tack Rule

Wind on the Starboard side of the vessel

- **STARBOARD TACK** boat is the **STAND ON** vessel.
- **PORT TACK** boat is the **GIVE WAY** vessel.

WIND

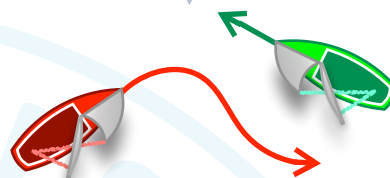

### UNDER SAIL



#### Windward Rule

The boat nearest the wind is the Windward boat. The boat furthest from the wind is the Leeward boat

- **LEEWARD** boat is the **STAND ON** vessel.
- **WINDWARD** boat is the **GIVE WAY** vessel.

WIND



### UNDER SAIL OR POWER



#### Overtaking Rule.

- The vessel **BEING OVERTAKEN** is the **STAND ON** vessel.
- The **OVERTAKING** vessel is the **GIVE WAY** vessel

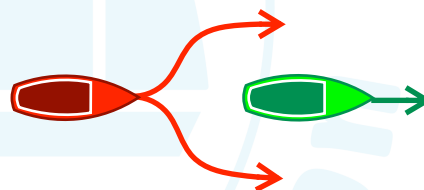

Overtaking is defined as coming from more than 22.5° abaft the beam (the angle a stern light becomes visible).

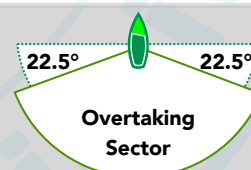

### UNDER POWER



Vessels meeting at an angle but not when one is overtaking the other, give way to vessels on your **STARBOARD BOW**.

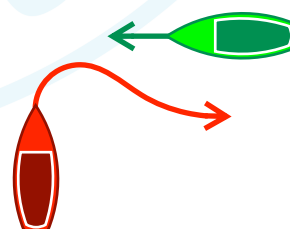

### UNDER POWER

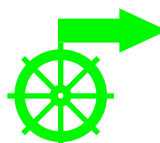

Vessels meeting head on – both turn significantly to **STARBOARD** and pass Port to Port.



SHAPES AND SOUNDS

VISUAL DAY SIGNAL

FOG SIGNAL

**1**  
Vessel engaged in diving operation

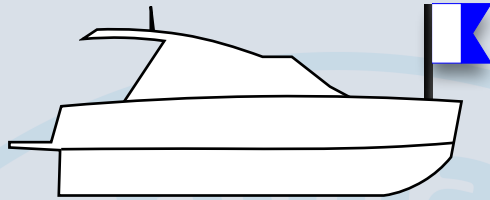

Efficient sound signal at intervals not exceeding 2 mins

**2**  
Vessel motor sailing

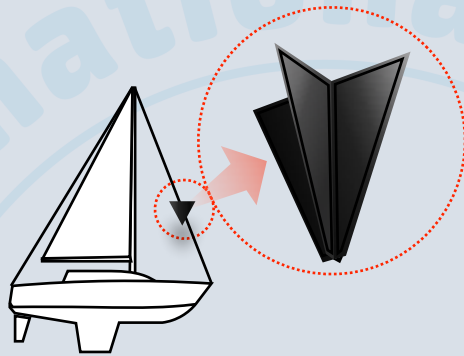

At intervals not exceeding 2 mins:

If making way



If not making way



**3**  
Power driven vessel constrained by draught

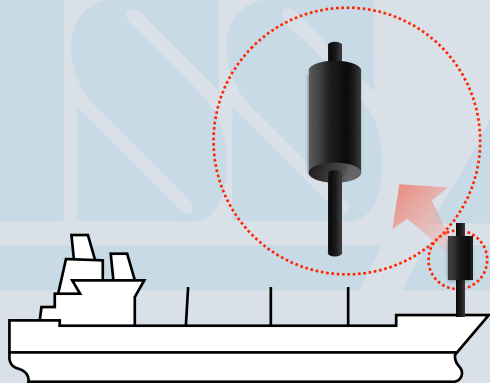

At intervals not exceeding 2 min



**4**  
Power driven vessel with restricted ability to maneuver

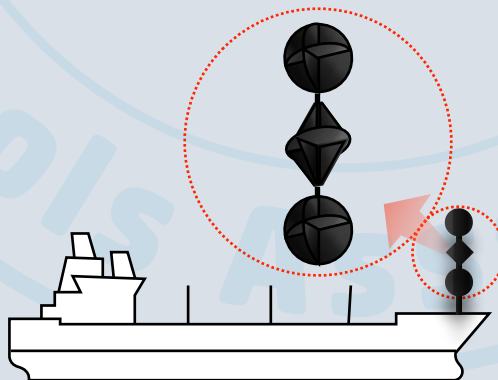

At intervals not exceeding 2 min



**5**  
Vessel towing and tow. Length of tow more than 200m

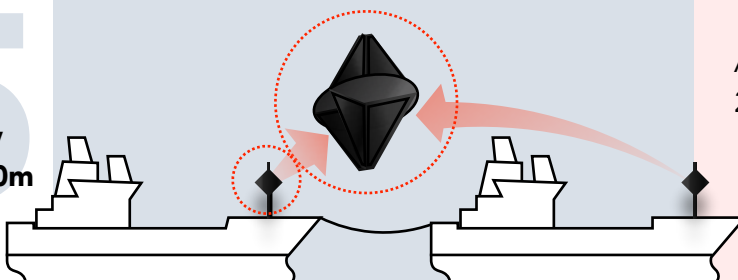

At intervals not exceeding 2 mins:

towing vessel



towed vessel





VISUAL DAY SIGNAL

FOG SIGNAL

**Fishing Vessel gear extending more than 150m horizontally**

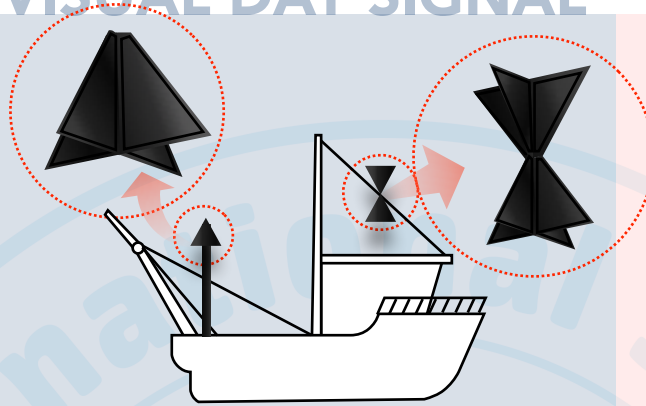

At intervals not exceeding 2 min



**Carrying out underwater operations (Restricted ability to maneuver)**

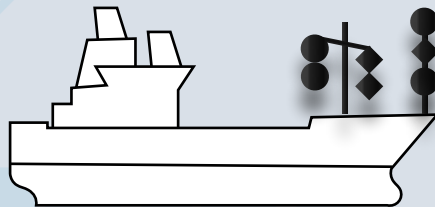

At intervals not exceeding 2 min

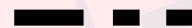

**Vessel at Anchor**



Rapid bell at intervals not exceeding 1 min. If over 100m followed by rapid gong. May also sound MORSE A on whistle



**Vessel not under command**

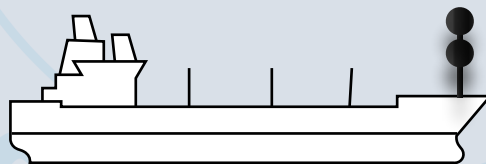

At intervals not exceeding 2 min



**Vessel aground**

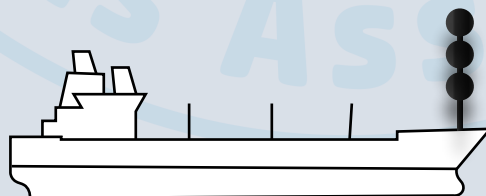

3 bell strokes + rapid ringing + 3 bell strokes + (gong if 100m plus). At intervals not exceeding 1 min. May also sound Morse R on whistle

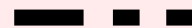

**Vessel engaged in mine clearing operations**

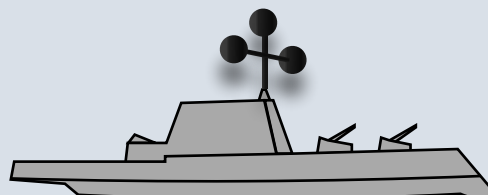

At intervals not exceeding 2 min



**LIGHTS**

AFT

FORWARD

STARBOARD

**Sailing vessels**

Under 20m a combined all-round mast light can be used

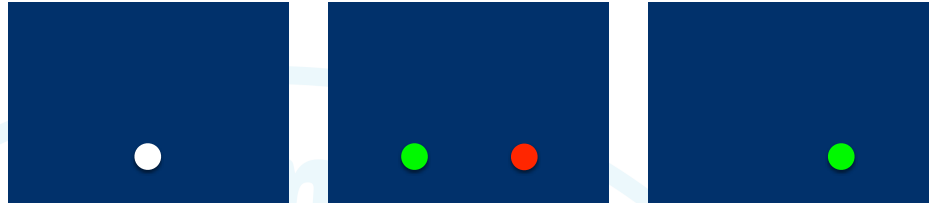

**Power vessel <50m**

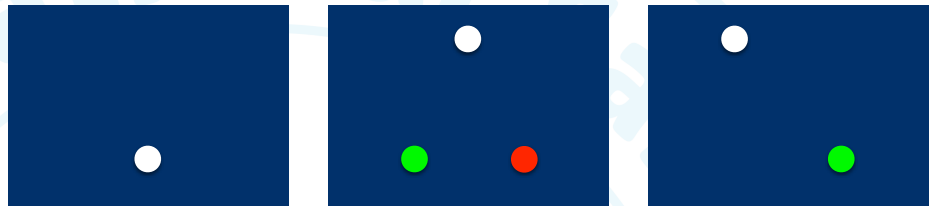

**Power vessel >50m**

When seen from forward it is impossible to distinguish this from a towing vessel < 50m with tow < 200m

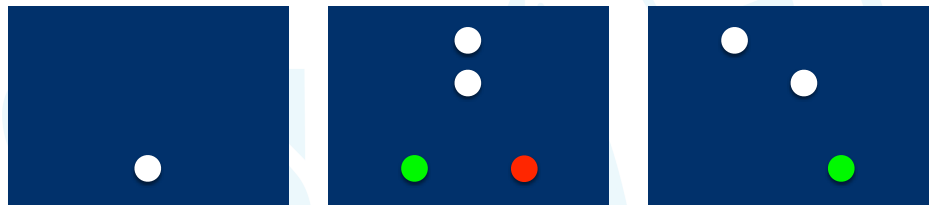

**Towing Vessel < 50m (tow < 200m)**

When seen from forward it is impossible to distinguish this from a power vessel > 50m or a power vessel < 50m showing the optional second masthead light

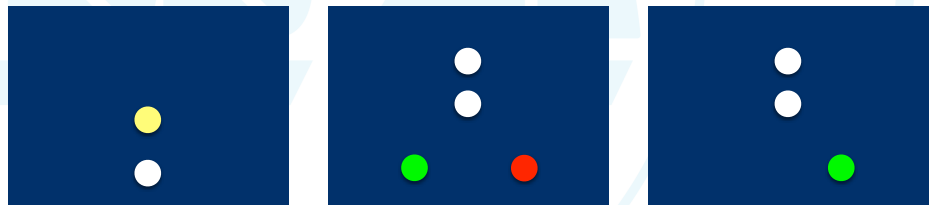

**Towing Vessel > 50m (tow < 200m)**

When seen from forward or aft it is impossible to distinguish this from a towing vessel < 50m with a tow > 200m

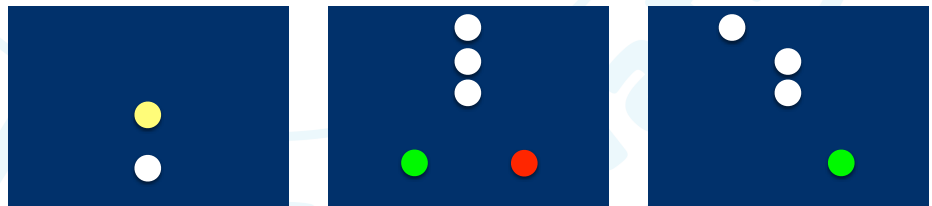

**Towing Vessel < 50m (tow > 200m)**

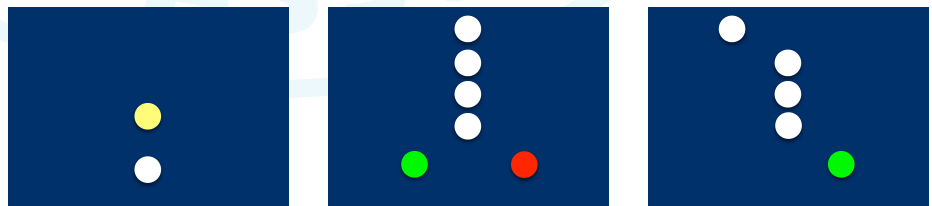

**Fishing Vessel**

Memory Aid:  
Red Over White = Fishing At Night

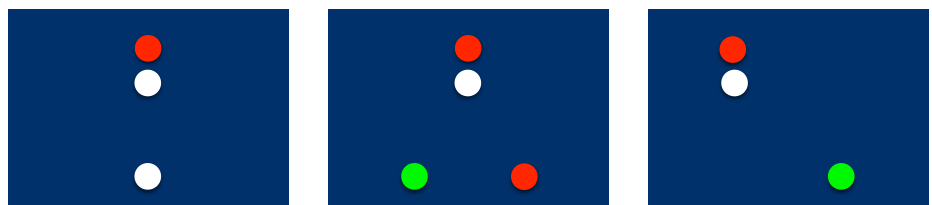

AFT

FORWARD

STARBOARD

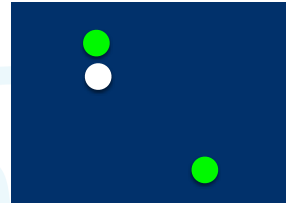
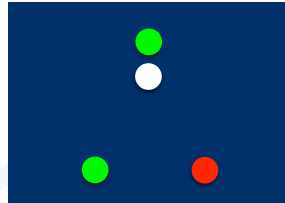
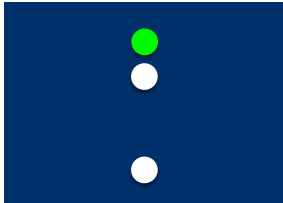

**Trawling Vessel**

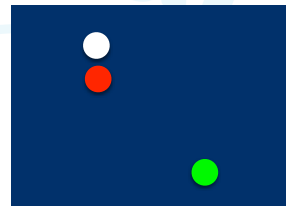
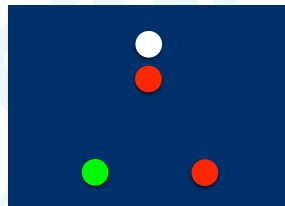
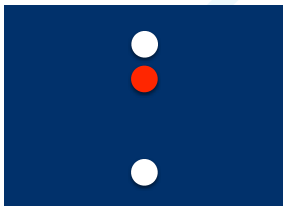

**Vessel engaged in pilotage duties**

Memory Aid:  
White over Red = Pilot Ahead



**Vessel < 50m At Anchor**

Remember, it is impossible to tell in many cases when only a single white light is seen - what this may mean (stern light? vessel at anchor? distant vessel where only the masthead light is visible over the horizon? etc...)

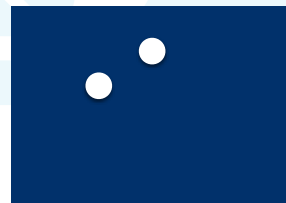
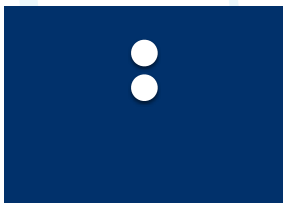

**Vessel > 50m At Anchor**

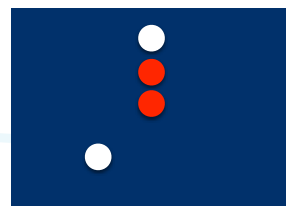
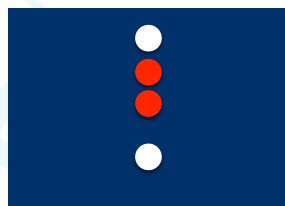
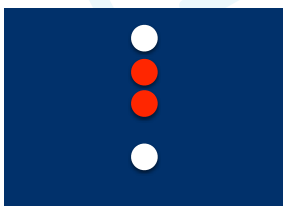

**Vessels Not Under Way - Vessel Aground**

Since the rule does not specify exactly where the two red lights should appear in relation to the anchor light they may appear either above or below the forward anchor light.

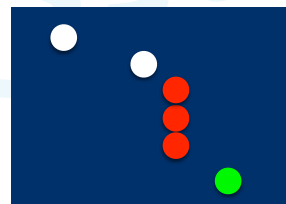
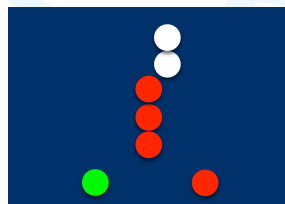
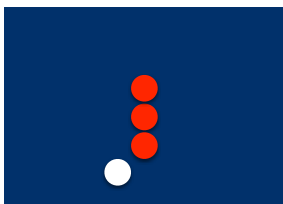

**Vessel Constrained by her Draft**

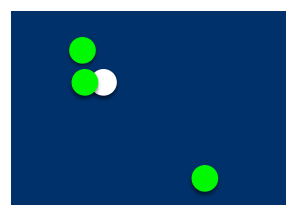
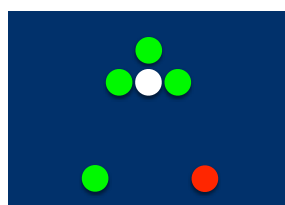
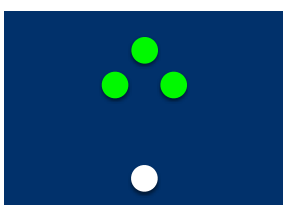

**Vessel engaged in mine clearance operations**

# Electronics

## KNOW YOUR SYSTEM

The modern yacht is fitted with several sensors and instruments with display units. The major instruments on a yacht are:

- GPS
- Depth Sounder
- Log
- Electronic Compass
- Wind Sensor
- VHF Radio
- Satellite phone
- AIS
- Radar
- Chart Plotter
- Auto Pilot

## GPS - GLOBAL POSITIONING SYSTEM

Handheld or mounted GPS devices are a must for any sailing boat today.

They provide reliable position fixing using Lat./Long. co-ordinates provided by 27 satellites orbiting the earth.

Waypoints for a route can be entered and distance/bearing from the boat to the destination are calculated in real-time and displayed on the device.

## DEPTH SOUNDER

Depth sounders are fitted under the hull or are handheld. They can display the depth in meters or feet of the sea beneath the hull.



If fitted under the hull, they need to be calibrated to either the keel or the bottom of the hull or the surface of the sea.

The sensor should be regularly cleaned of barnacles.

On a new boat, inquire about the calibration of the sounder to avoid confusion.

## ELECTRONIC LOG

The modern yacht is fitted with low power instruments that record depth and speed.

The Speed/Log records the water track speed. It is wired to the main ship computer and then to the multi display in the cockpit.

The small wheel can get clogged and it should be carefully checked and be cleaned weekly.



## ELECTRONIC COMPASS

The Electronic Compass display complements the standard magnetic compass but does not replace it.

It is mostly used in conjunction with the auto-pilot for keeping a bearing based on a compass course.

It can be calibrated to display True or Magnetic course.



## WIND SENSOR

Mounted at the top of the mast is the wind sensor that monitors the speed of the wind and its direction.

The display monitor can display the Apparent Wind or True Wind speed in knots.

In addition the display monitor can display the wind direction.

An auto-pilot can also steer a course based on the wind speed monitored by this device.



## VHF RADIO

Marine radio transmitting and receiving on a radio frequency range between 156.0 and 162.025 MHz.

Use Channel 16 to monitor or send messages of high importance (Distress, Urgency and Safety).

Can be mounted with antenna or hand held.

Only operates with a radius of about 15-25 NM depending on the height of the antenna (range is 1.23 times the root of antenna height in feet).



## SATELLITE PHONE

Satellite phones are becoming more prevalent on boats and are starting to replace Single Band radios.

Allow for two-way voice and data communication anywhere in the world.

Small form factor and low power consumption.

## AIS - AUTOMATED IDENTIFICATION SYSTEM

AIS stands for Automatic Identification System, the international automated collision avoidance system.

Commercial ships are required to carry both an AIS transmitter and receiver.

Leisure boats should have an AIS receiver.

AIS receivers will display information about ships in the vicinity and their course/speed and possibly the risk of collision.

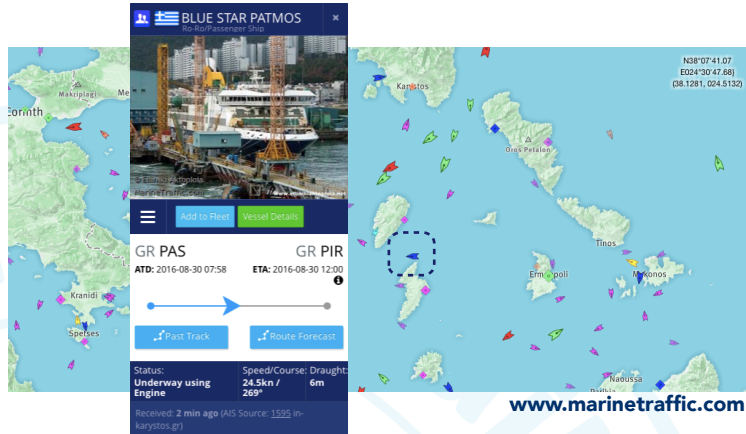

## IPAD / TABLET

These devices can be used to access navigational, pilotage, weather information all over the world by accessing the internet or by installing software such as 'Navionics'.

## RADAR

Radar allows visibility at night or when there is fog. It shows ships, land and other objects in the vicinity.

Radar can also detect squalls.

Radar allow for position fixes using bearing and distance to objects and land when there is no visibility.

Comes with an antenna mounted on the mast and a display unit.

## CHARTPLOTTER

Chart plotters are multi function devices with built-in digital maps of specific sailing areas.

In conjunction with GPS, they allow the skipper to set waypoints, routes, keep track of the ships course.

Chart plotters allow for sailing regions to be zoomed to and display details not normally found on paper charts.

Small screen size can however hinder danger zones.

## AUTOPILOT

The Autopilot is a great addition to a vessels instruments.

The autopilot can steer the boat automatically based on a waypoint, a compass course, a wind direction.

It comprises a hydraulic arm and an electronic control system.

Autopilot does not replace the helmsman.

Can be used in conjunction with a GPS and a radar when the helmsman needs to rest and no other crew can steer the boat.

# First Aid at sea

## FIRST AID PREPARATION

A good skipper is always prepared.

He or another person on the crew should have some knowledge of first aid.

One-day courses are available at most good sailing schools.

### Check all safety equipment is in date

- ▶ Heavy line with life buoy.
- ▶ Fire extinguishers.
- ▶ Signal flares and other signaling devices with current expiration dates.
- ▶ Life jacket suitable for each person on board, readily accessible, in good condition.
- ▶ MOB equipment and throwable flotation device easily accessible to helmsman.
- ▶ Flashlight and extra batteries.
- ▶ Horn or sound signaling device.
- ▶ Bell.
- ▶ Comprehensive first aid kit.
- ▶ Bailer or manual water pump.
- ▶ Sufficient foul weather gear, warm clothing & safety harnesses for all crew.

## FIRST AID KIT

It is important to have a comprehensive first aid kit on board every boat. Your first aid kit should include the following as a minimum:

- ▶ Antibiotics (wound infections, prevention of infections: urinary tract, throat, etc., insects bites, others.).
- ▶ Eye drops.
- ▶ Allergies.
- ▶ Anti-pain.
- ▶ Diarrhea.
- ▶ Constipation.
- ▶ Stomach pain.
- ▶ Sedatives.
- ▶ Something for the flu/cold/cough.
- ▶ Injuries: bandages of various sizes, sterile compresses, surgeon gloves (sterile), ordinary gloves - several pairs, wound stickers, mesh to hold the dressing.
- ▶ aseptic + antiseptic + burns.
- ▶ Other: syringe, thermometer, pocket mask (rescue mask).

## IN AN EMERGENCY

When there is a medical emergency onboard the captain or member of crew can put in a Pan Pan (non-life threatening) or Mayday (life threatening) call for help. Even if you require medical advice a Pan Pan Medico call can be made.



## HYPOTHERMIA

Hypothermia is a condition in which exposure to cold air and/or water lowers body core temperature.

The symptoms include shivering, lethargy, stumbling, slurred speech, and loss of memory. The victim progressively develops a cold pale skin, slow breathing and a slow weak pulse, leading to collapse and unconsciousness.

1. Your first aim is to **prevent further heat loss**. Get the casualty out of the sea and out of the wind.
2. Get the casualty to the warmest spot on board and turn on all the heating. As soon as possible strip off all wet clothing, if necessary by cutting it off. **Do not rub the skin to dry it, but dab it dry with a towel.**
3. If the casualty is conscious get them into warm dry clothing, give them **lots of warm sweet drinks** and allow them to rest in a warm sheltered spot. If you have no other means of providing warmth get close enough to **transfer body heat**.
4. If the casualty is unconscious take off all their wet clothing and **put them in a sleeping bag**. Make sure they are in the recovery position and won't suffocate.
5. If the boat will take time to warm up, get into the sleeping bag with the casualty. **(Wear tight clothing to speed up transfer of heat.)**

## HEAD INJURIES

Head injuries can be common on boats. It is important to be able to identify the symptoms of concussion.

- Headache or "pressure" in head.
- Nausea or vomiting.
- Balance problems or dizziness, or double or blurry vision.
- Bothered by light or noise.
- Feeling sluggish, hazy, foggy, or groggy.
- Confusion, or concentration or memory problems.
- Just not "feeling right," or "feeling down".

## BLEEDING

Minor scrapes, cuts and bruising are easily treated.

1. **Wear gloves** and other barriers to protect yourself and patient from disease transmission.
2. If necessary **control bleeding** with direct pressure.
3. **Use disinfectant** (like Betadine) to remove dirt and parcels around the wound.
4. **Cover wound** with a non-adhesive dressing and bandage securely.
5. **Check wound** daily for signs of infection.



## First Aid at sea

**Serious bleeding requires specialty medical treatment as soon as possible.** A Mayday call should be placed if the casualty is gushing blood. While waiting for medical treatment the following can be done to try and reduce blood loss.

1. **Wear gloves** and other barriers to protect yourself and patient from disease transmission.
2. **Place a clean cloth** or a sterile dressing **over the wound** and apply **direct pressure**. If a dressing or cloth is not available use a gloved hand.
3. While applying direct pressure on wound, **place a pressure bandage** over the sterile dressing.
4. If bandage becomes blood-soaked, **place another clean cloth** or dressing on top and bandage in place.
5. **Continue** to apply **direct pressure**.
6. **Do not remove blood-soaked bandages** as blood clots in the dressing help control bleeding. Add bandages as necessary.

### MINOR BURNS

1. **Wear gloves** and other barriers to protect yourself and patient from disease transmission.
2. **Flush or soak burn in cool water** for at least 15 min. If possible, **remove jewelry**, watched belts or constricting items from the area before it begins to swell.
3. **Cover area with a sterile** (non-fluffy) dressing and bandage loosely.
4. **Check burn daily** for signs of infection.

### MAJOR BURNS

A Mayday call should be placed as soon as possible for a Major burn. While waiting for emergency response the following can be done to help the casualty.

1. **Wear gloves** and other barriers to protect yourself and patient from disease transmission.
2. **Help the patient lie down** but ensure the burnt area does not come into contact with the ground.
3. **Douse the burnt area with cold liquid** for at least 10 minutes. Continue cooling the area until pain is relieved.
4. **Carefully remove clothing** from around the burnt area and **remove any constricting items** before swelling begins.
5. **Cover burns with a sterile dressing** or other non-fluffy material available. Cling film could also be used if applied lengthways.
6. **Continue to monitor the patient** until emergency response arrives.



# Environmentally Responsible Sailing

**Holders** of the International Sailing Schools Association **certificates** are the **elite** that knows how to sail safely and should also **care about the environment**. Help us promote Environmentally Responsible Sailing and preserve the nature for future sailors generations **by applying these few simple rules**.

## Use your sails as much as possible therefore reducing energy consumption



Sailing is a very environmentally friendly form of transport as it harnesses the wind and sea without detriment to the environment. Maximise the use of sails subject to safety and operational requirements.

## Segregate garbage for recycling purposes wherever possible



Recycling is an alternative to "conventional" waste disposal that can save material and help lower greenhouse gas emissions. Recycling prevents the waste of potentially useful materials and reduce the consumption of fresh raw materials, thereby reducing: energy usage, air pollution (from incineration), and water pollution. Search for segregated garbage bins in every marina.

## Strictly enforce no waste being thrown overboard.



This is not even a matter of ecology but personal culture. Oceans and seas are huge, but that does not mean that another piece of paper thrown into the water does not make a difference. It does. It is your attitude that matters.

## Leave any beach or shore line you visit cleaner than when you arrived.



Leisure sailing can take you to many beautiful, paradise-like places. The community of sailors grows every year and it is constantly harder and harder to visit places untouched by a human hand. Some people do not regard that as a value and leave their trash behind them there. React and help to keep those places safe.

## Educate sailing guests on the ecology of the sea and shore.



You are the skipper. It is your responsibility to educate your crew on how to properly behave during your leisure yachting experience.



# Topics Checklist

## THEORETICAL TOPICS

Taking over a vessel	
Meteorology	
Pilotage and passage planning	
Vessel handling	
Chartwork	
Collision Regulations	

## PRACTICAL TOPICS

Vessel Check-out	
Responsibilities of Captain/Skipper	
Seamanship	
Vessel Handling	

NAME

This is to certify that the student, \_\_\_\_\_  
has an understanding of the above topics and has achieved the level of INSHORE SKIPPER.

NAME

Instructor

DD.MM.YYYY

Date

Instructor's signature



**ISSA.global**

*Wherever You Sail*