



ISSA

YACHT

CREW

**STUDENT
HANDBOOK**



TABLE OF CONTENTS

| | |
|---------------------------|----------|
| YACHT CONSTRUCTION | 2 |
| KNOTS | 3 |
| SAILS AND RIGGING | 4 |
| SAILING EQUIPMENT | 5 |
| SAFETY ON BOARD | 6 |

YACHT CONSTRUCTION

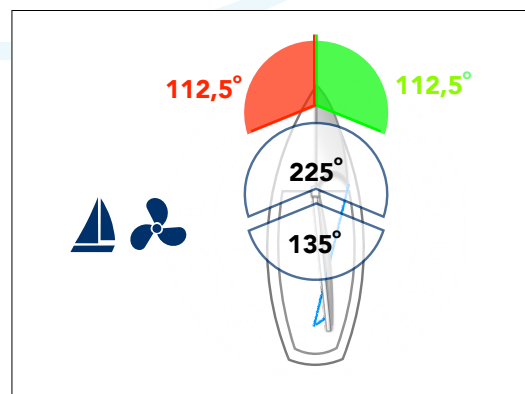
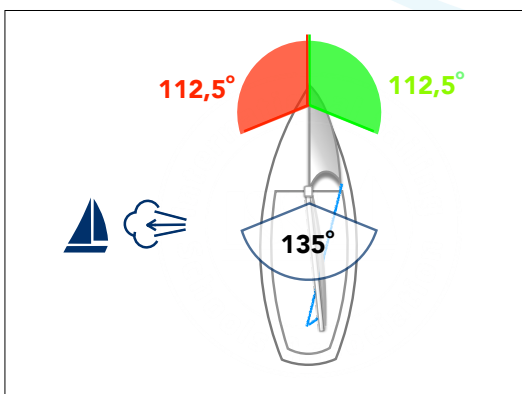
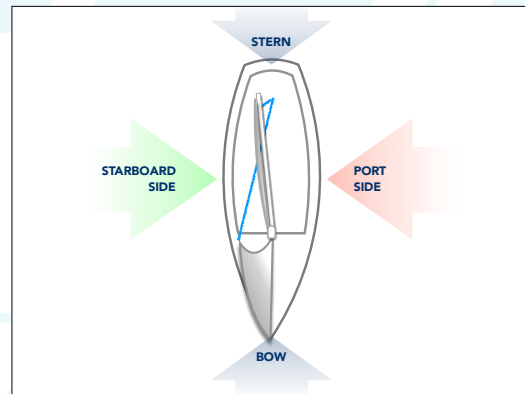
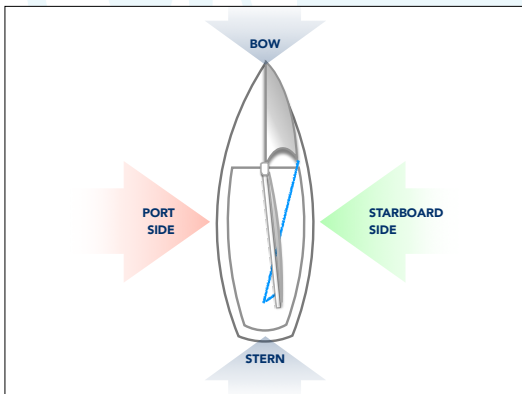
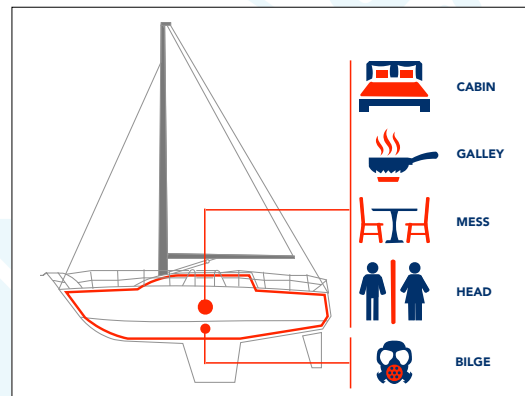
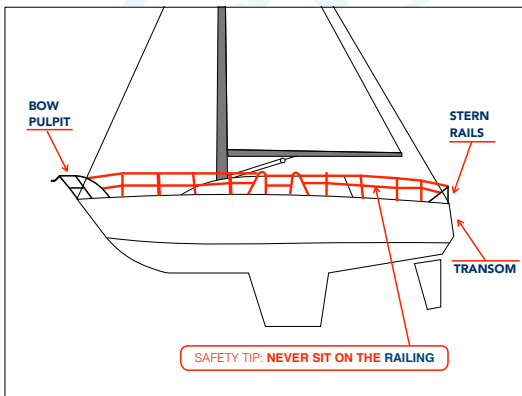
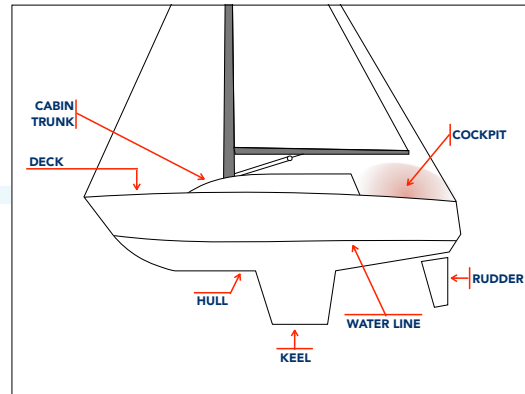
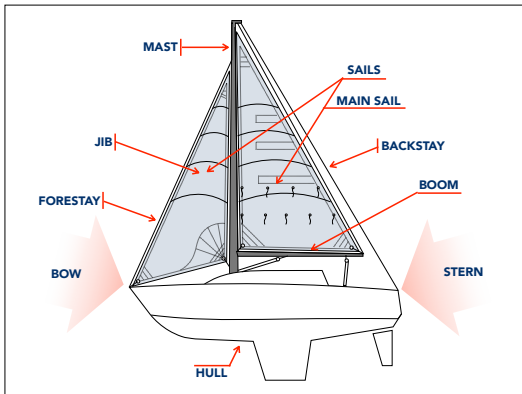

KNOTS

BOWLINE

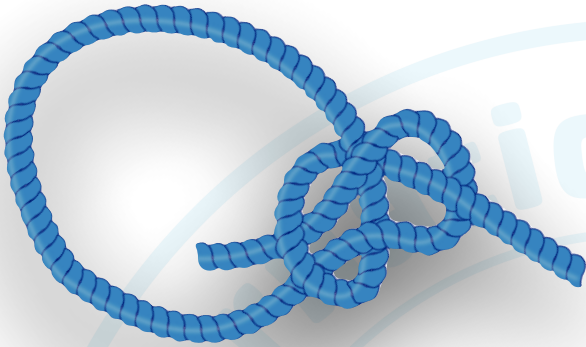

ROUND TURN & TWO HALF HITCHES

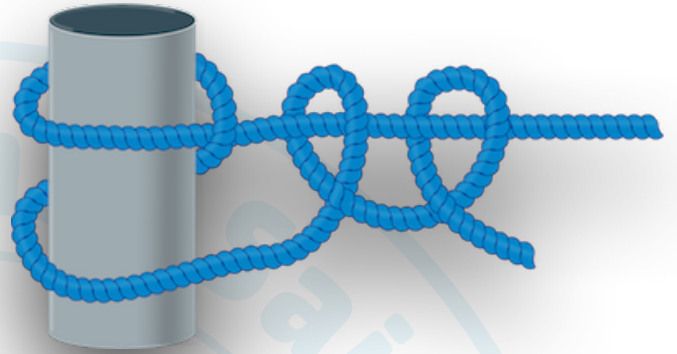

EIGHT

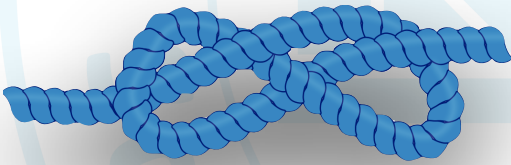

REEF

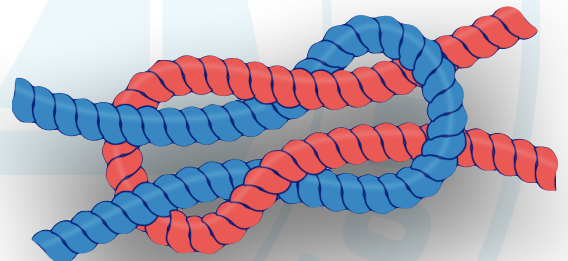

HORN CLEAT KNOT

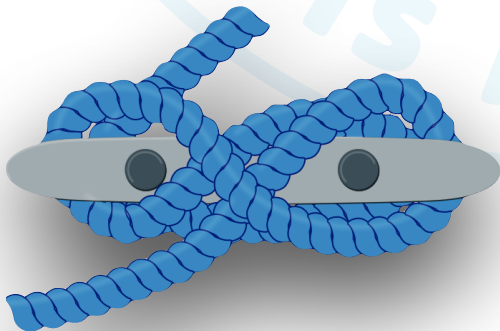

CLOVE HITCH



SAILS AND RIGGING

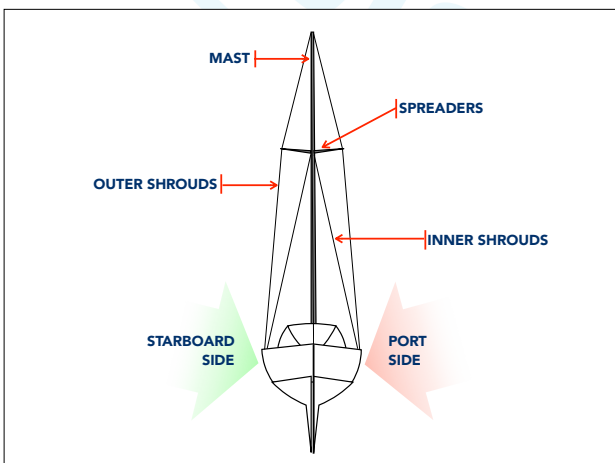
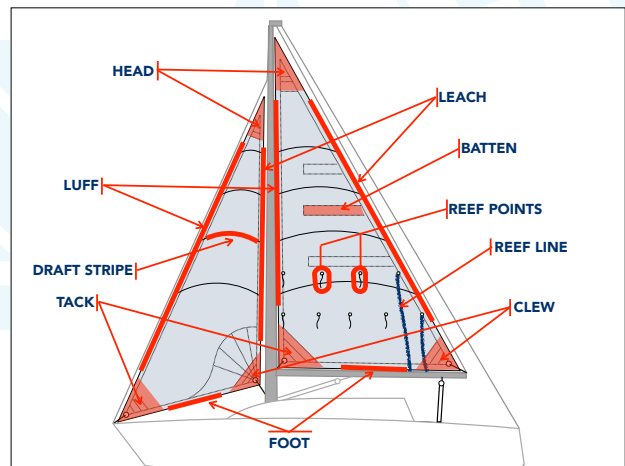
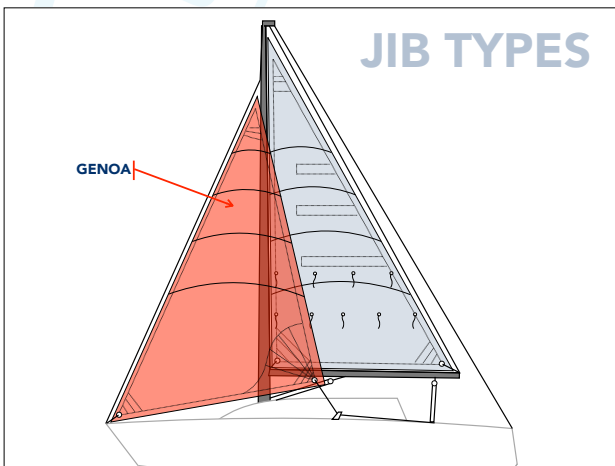
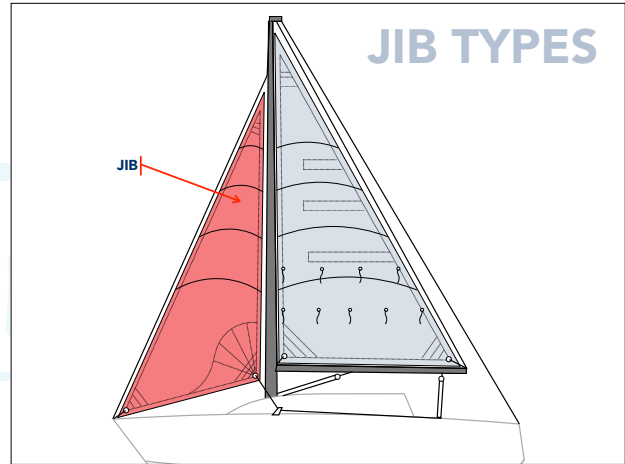
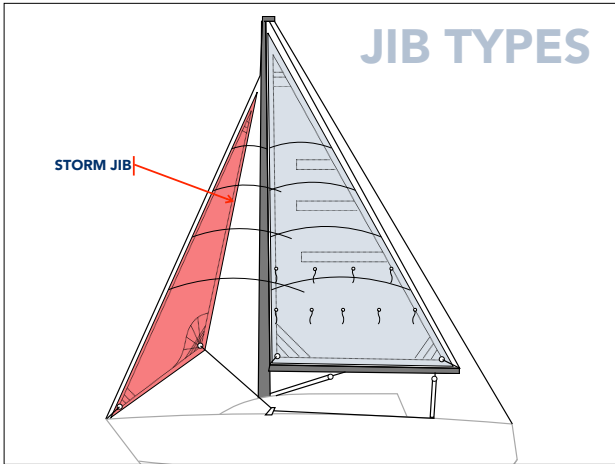

.....

.....

.....

.....

.....

.....

.....

.....

SAILING EQUIPMENT

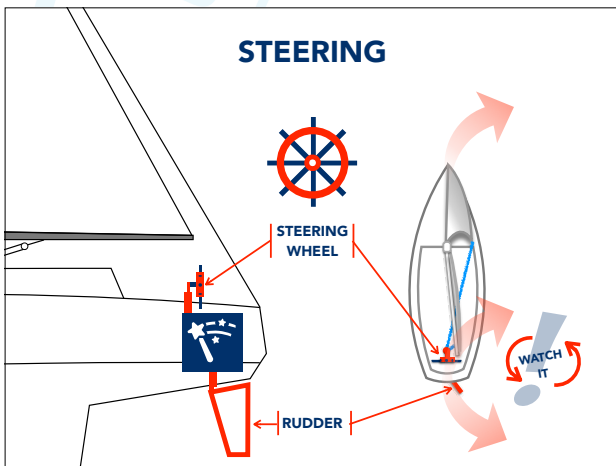
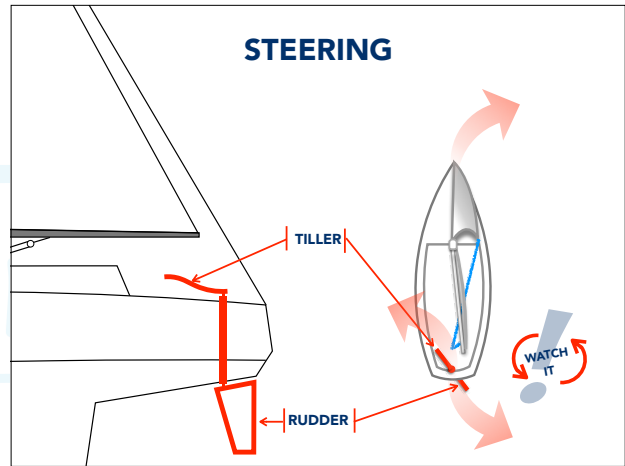
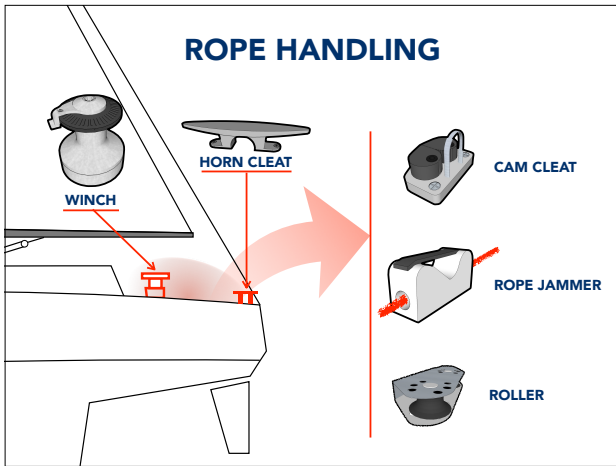

.....

.....

.....

.....

.....

.....

.....

.....

.....

.....

.....

.....

.....

.....

.....

SAFETY ON BOARD



PREPARE YOURSELF

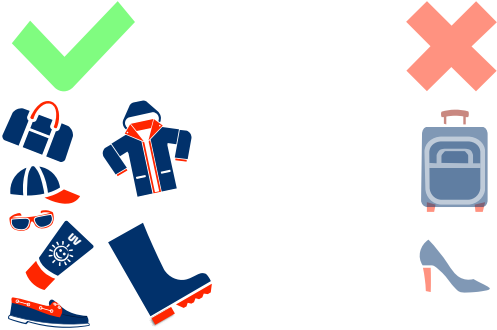

BASIC SAFETY RULES

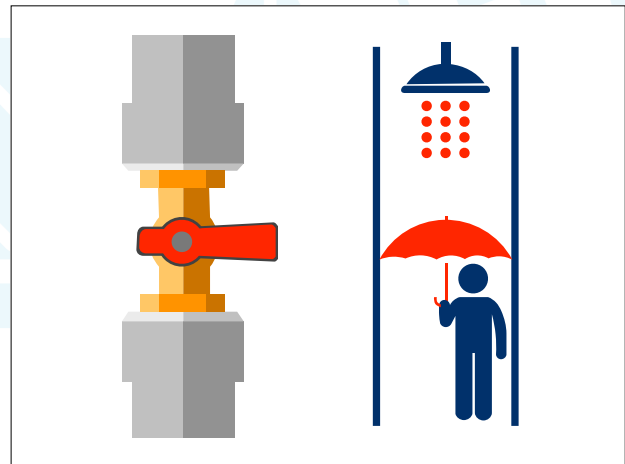
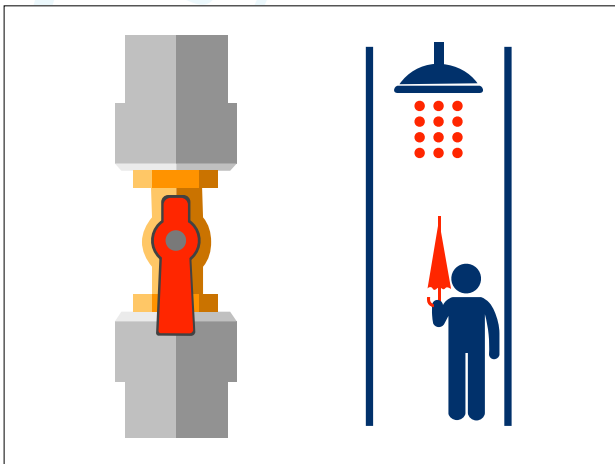
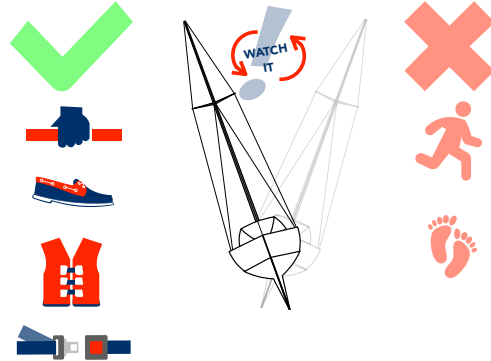

GALLEY - TURNING ON GAS

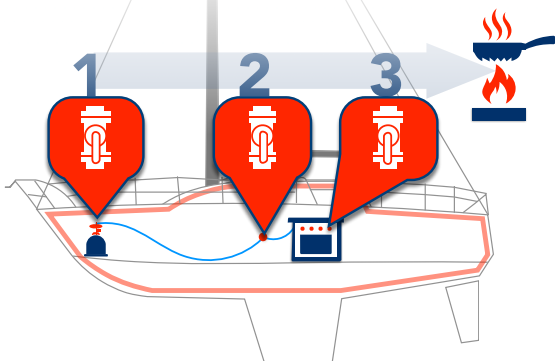

GALLEY - TURNING OFF GAS

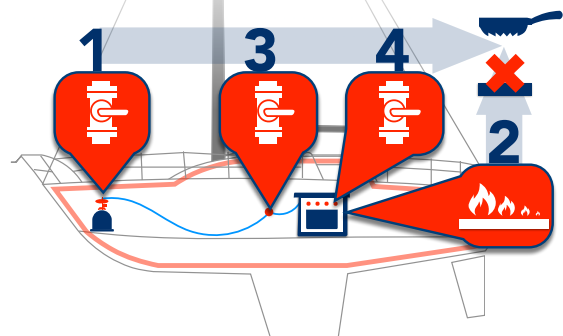

SAFETY ON BOARD

HEAD

HEAD

HEAD

50 LITERS

30 LITERS

SAVE WATER

FUSE BOARD

| 12V DC | | 230V AC | |
|-------------------|--------------------------|------------------|--------------------------|
| ANCHOR LIGHT | <input type="checkbox"/> | AC MAINS | <input type="checkbox"/> |
| STEERING LIGHT | <input type="checkbox"/> | TV | <input type="checkbox"/> |
| DECK LIGHT | <input type="checkbox"/> | AC OUTLETS | <input type="checkbox"/> |
| NAVIGATION LIGHTS | <input type="checkbox"/> | SPARE | <input type="checkbox"/> |
| CABIN LIGHTS | <input type="checkbox"/> | | |
| COMPASS LIGHT | <input type="checkbox"/> | | |
| WINCH | <input type="checkbox"/> | | |
| INSTRUMENTS | <input type="checkbox"/> | | |
| VHF RADIO | <input type="checkbox"/> | FRESH WATER PUMP | <input type="checkbox"/> |
| VHF RADIO | <input type="checkbox"/> | SHOWER DRAIN | <input type="checkbox"/> |
| DC OUTLETS | <input type="checkbox"/> | BILGE PUMP | <input type="checkbox"/> |
| | | REFRIGERATOR | <input type="checkbox"/> |
| | | STEREO | <input type="checkbox"/> |
| | | SPARE | <input type="checkbox"/> |

ENGINE CHECK

ENGINE START

- INSTRUMENTS
- KEY / ON
- GLOW 10sec
- KEY / START
- WATER
- Gauge

SAFETY ON BOARD

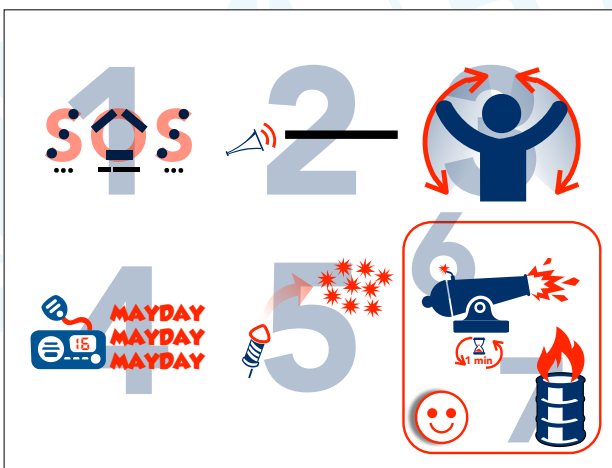
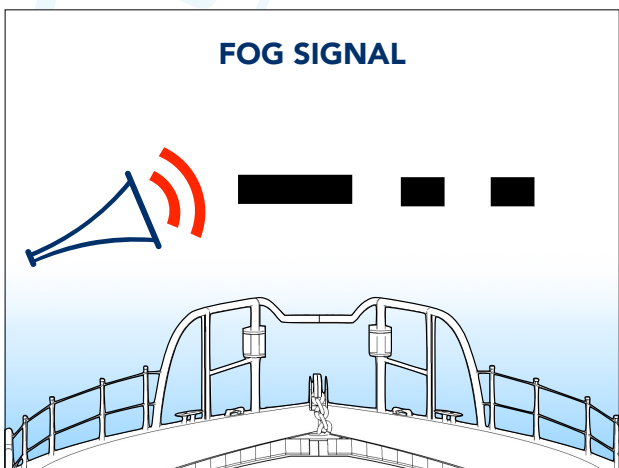
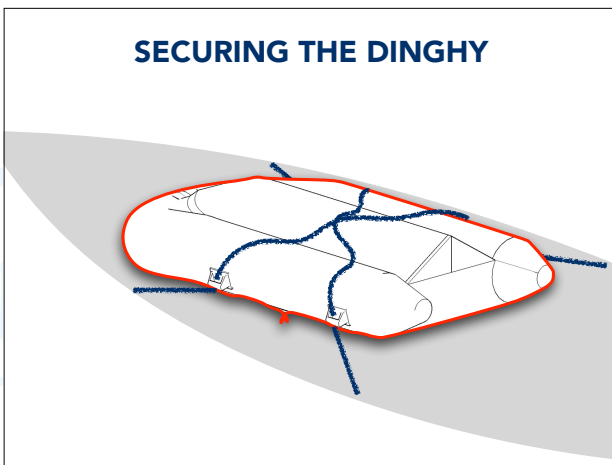
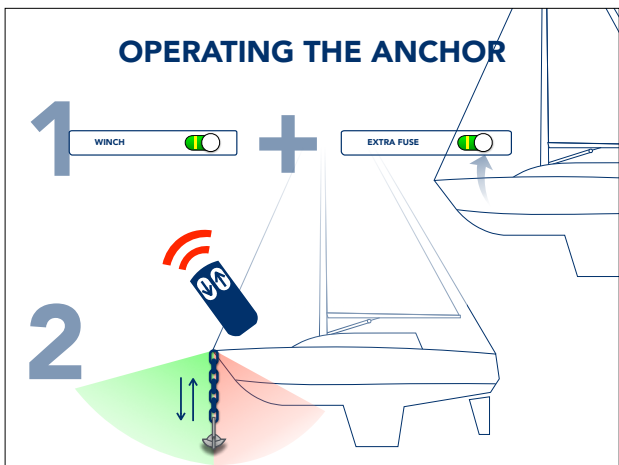



ISSA.global

Wherever You Sail